

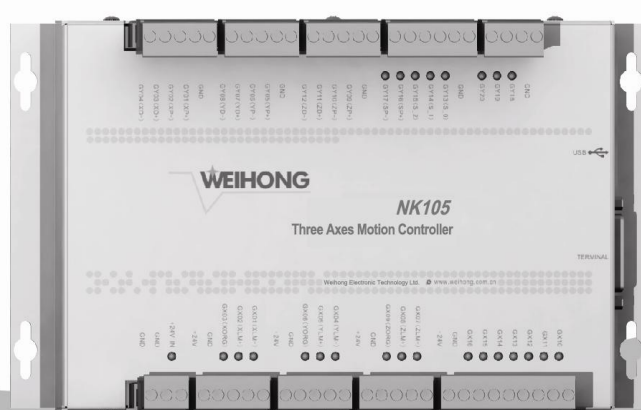

NK105G2/G3 Control System Manufacturers' Manual



Preface

Thank you for choosing our products.

This manual will acquaint you with such detailed information of NK105G2/G3 integrated CNC system as system components, setup, and usage, etc.

It introduces the process of system installing and various functions of the system. Before using this system and related equipment, please read through this manual, which will help you have a better use of them.

Because of continuous updating of hardware and software, the products you bought may differ from the written in this manual.

Company address, phone number and our website are listed here for your convenience. Any questions, please feel free to contact us. We will always be here and welcome you.

Company Name:	Weihong Electronic Technology Co., Ltd.
Headquarters Address:	No. 29, 2338 Duhui Rd., Minhang, Shanghai
Zip Code:	201108
Tel:	+86-21-33587550
Fax:	+86-21-33587519
Website:	http://en.weihong.com.cn
E-mail:	sales_weihong@188.com ; support_weihong@188.com

Precautions:

◆ Storage and Transportation

Attention
<ul style="list-style-type: none">➤ The products should be transported properly in terms of the weight;➤ An excess of specified quantity of stacking products is prohibited;➤ Climbing, standing or placing heavy loads on the products is prohibited;➤ Dragging or carrying the products via cables or devices connected to them is prohibited;➤ Keep the products free from moisture during storage and transportation.

◆ After Opening the Package

Attention
<ul style="list-style-type: none">➤ Please make sure whether the products are what you have ordered;➤ Check if the products are damaged in transit;➤ Check if the components and accessories are damaged or missing in terms of the detailed list;➤ Please contact us promptly if product discrepancy, accessory missing or transit damage occurs.

◆ **Installation Notices**

Attention

- Only when this equipment is installed in the qualified electricity cabinet can it be used. The construction of the cabinet must reach IP54 grade of protection;
- Paste sealing strips on the joint of the cabinet to seal all the cracks;
- Cable entry should be sealed while easy-to-open on the spot;
- A fan or a heat exchanger should be adopted for the heat dissipation and air convection of the cabinet;
- If a fan is adopted, air strainer is a must in air inlet or air outlet;
- Dust or cutting fluids may have access to the CNC device via the tiny cracks and tuyere. Therefore it is necessary to pay attention to the surroundings and air flow direction of the air vent to make sure that the outflow gas is towards pollution source;
- 100mm space should be preserved between the back of the CNC device and the cabinet wall for plugging cable connected with the device and for the ventilation & heat dissipation in the cabinet;
- Space between this device and other equipments should also be preserved according to the requirements;
- The product should be installed firmly and without vibration. During installing, casting, knocking, striking, or loading on the product is forbidden;
- To reduce electromagnetic interference, power-supply components used should be above AC or DC 50V and the space between cable and the CNC device should be preserved above 100mm;
- It will be better if the CNC device is installed at the position facilitating debugging and maintenance.

◆ Wiring Notices**Attention**

- Only qualified people are allowed to participate in the wiring and checking.
- The CNC device should be grounded reliably and the grounding resistance should be less than 4 ohm. Neutral line is absolutely not allowed to replace earth wire. Otherwise, the device may be likely to work improperly due to the interference.
- Wiring should be firm and steady, or misoperation may occur.
- Voltage values and positive & negative polarity of any connection plug should be in accordance with the manual, or such breakdowns as short circuit and device permanent damage may occur.
- To guard against electric shock or the CNC device damage, fingers should keep dry before plugging or touching switch.
- The connecting wire should not be damaged and squeezed, or the leakage or short circuit may occur.
- It is prohibited to plug or open the chassis of CNC device when power on.

◆ Running & Debugging Notices**Attention**

- Parameters setting should be checked before running, since wrong setting may lead to accidental movements.
- Modification to parameters should be within the allowable range, or such breakdowns as unsteady running and machine damage will occur.

◆ **Precautions in Use**

Attention

- Before power-on, please make sure that the switch is on blackout to avoid occasional start-up.
- Please check the electromagnetic compatibility during electrical design in order to avoid or reduce electromagnetic interference to the CNC device. A low pass filter should be employed to reduce electromagnetic interference if there are other electrical devices nearby.
- It is not allowed to frequently power on and power off. It is recommended 1 minute interval at least after power failure or blackout before power on again.
- Firmly hold the handheld box, a mobile control terminal, when moving it to ensure the accuracy, promptness and safety of control, in case it falls off to the ground or collides with sharp instruments and causes component damage and control failure, etc.

Contents

1. Summarization	1
1.1. System Introduction	1
1.2. Basic Configuration	1
1.3. Mechanical Dimension	1
2. Wiring Method	3
2.1. Terminal Specification	3
2.1.1. Terminal Wiring When General Software Installed	3
2.2. Input Interface of +24V Power	5
2.3. USB Interface	5
3. Basic Concepts	6
3.1. Operation Mode and State	6
3.1.1. Operation Mode	6
3.1.2. Operation State	6
3.2. Coordinate System	7
3.2.1. Machine Coordinate System	7
3.2.2. Workpiece Coordinate System	8
4. Functions & Operation Methods of Panel Keys	10
4.1. NK105G2 Panel Keys	10
4.1.1. Function Information of Each Single-key	10
4.1.2. Function Information of Combination Key	12
4.2. NK105G3 Panel Keys	13
4.2.1. Function Information of Each Single-key	13
4.2.2. Function Information of Combination Key	15
4.3. Modification Method of System Parameters	15
4.4. System Start-up	16
5. Machine Tool Debugging	18
5.1. Adjustment of Axis Direction and Pulse Equivalent	18
5.1.1. Adjustment of Axis Direction	18
5.1.2. Adjustment of Pulse Equivalent	18
5.2. Setup of Machine Stroke	20

5.3.	Port Polarity	20
5.4.	Back to Machine Origin	22
5.4.1.	Parameter Setup of Backing to Machine Origin	22
5.4.2.	Operation Mode of Backing to Machine origin.....	22
5.5.	Spindle Debugging	23
5.5.1.	Spindle Setup.....	23
5.5.2.	Park MCS Site	24
5.5.3.	Spindle Stop.....	25
5.6.	Manual Machining.....	25
5.6.1.	Mode Selection of Manual Machining.....	25
5.6.2.	Parameter Setting of Manual Machining	26
5.7.	Automatic Machining	27
5.7.1.	Load File	27
5.7.2.	WCS Selection.....	28
5.7.3.	Set Workpiece Origin	28
5.7.4.	Start Machining	29
5.8.	Adjustment during Automatic Machining	29
5.8.1.	Feedrate Override Adjustment.....	29
5.8.2.	Spindle Speed Adjustment	29
5.8.3.	Machining Pause and Jiggle.....	30
5.8.4.	Continuing Machining after Pause.....	30
5.8.5.	Soft Limit Handling.....	30
5.8.6.	Hard Limit Handling	31
6.	Menu Page	32
6.1.	Summarization.....	32
6.2.	Local Files/ USB Files	33
6.3.	Operations	34
6.3.1.	Back REF Point.....	34
6.3.2.	Rect Machining	35
6.3.3.	Select Line No.....	35
6.3.4.	Machining Info.....	36
6.3.5.	Park MCS Site	36
6.3.6.	Select WCS.....	36
6.3.7.	Array Process	36
6.3.8.	Origin List.....	37

6.3.9.	Nearby Process	37
6.4.	Oper Param (Operator Parameters).....	37
6.5.	Mfr Param (Manufacturer Parameters)	40
6.6.	Param Upkeep (Parameter Maintenance).....	44
6.6.1.	Backup Params.....	45
6.6.2.	Restore Backup	45
6.6.3.	Factory Params.....	45
6.6.4.	Export Parameters	46
6.6.5.	Import Parameters	46
6.7.	System Upkeep	46
6.7.1.	Language	46
6.7.2.	Export Log.....	47
6.7.3.	System Update	47
6.7.4.	Register.....	48
6.7.5.	Help.....	48
6.7.6.	Reboot	48
6.7.7.	Exit	48
6.7.8.	Delete Log.....	49
6.7.9.	Disk Space	49
6.7.10.	Delete Info.....	49
6.7.11.	Modify Code.....	49
6.8.	Diagnosis	49
6.8.1.	System Info	49
6.8.2.	Ports List	49
6.8.3.	Keypress Diag.....	50
6.8.4.	Inport Diag	50
6.8.5.	Outport Diag.....	50
6.8.6.	LED Diag.....	50
7.	Machining Operations of NK105G3.....	51
7.1.	Manual Machining.....	51
7.1.1.	Mode Selection of Manual Machining.....	51
7.1.2.	Parameter Setting of Manual Machining	52
7.2.	Automatic Machining	52
7.2.1.	Load File	53
7.2.2.	WCS Selection.....	53

7.2.3.	Set Workpiece Origin	54
7.2.4.	Start Machining	54
7.3.	Adjustment during Automatic Machining	55
7.3.1.	Feedrate Override Adjustment	55
7.3.2.	Spindle Speed Adjustment	55
7.3.3.	Machining Pause and Jiggle	55
7.3.4.	Soft Limit Handling	56
7.3.5.	Hard Limit Handling	56
7.3.6.	E-stop Handling	56
8.	System Update	58
8.1.	Software Update	58
8.2.	System Mirror Update	58
9.	Driver	60
9.1.	Driver parameters	60
9.1.1.	Parameter Setting of YASKAWA Σ - II Servo Driver	60
9.1.2.	Parameter Setting of DELTA ASDA-A Servo Driver	62
9.1.3.	Parameter Setting of DELTA ASDA-A2 Servo Driver	64
9.1.4.	Parameter Setting of PANASONIC MINAS_A4 Servo Driver	66
9.1.5.	Parameter Setting of FUJI FALDIC- β Servo Driver	67
9.1.6.	Parameter Setting of STONE GS Servo Driver	68
9.1.7.	Parameter Setting of MITSUBISHI MR-E Servo Driver	69
9.2.	Wiring Diagram of NK105 and Driver	71
9.2.1.	Wiring Diagram of NK105 and Differential Input Stepping Driver	71
9.2.2.	Wiring Diagram of YASKAWA Σ - II Servo Driver	71
9.2.3.	Wiring Diagram of DELTA ASDA Servo Driver	72
9.2.4.	Wiring Diagram of PANASONIC MINAS_A4 Servo Driver	73
9.2.5.	Wiring Diagram of MITSUBISHI MR-E Servo Driver	73
9.2.6.	Wiring Diagram of FUJI FALDIC- β Servo Driver	74
9.2.7.	Wiring Diagram of STONE GS Servo Driver	74
10.	Software License Agreement	75

1. Summarization

1.1. System Introduction

Independently-developed NK105G2/G3 provides a whole set of solutions to engraving machines based on embedded industrial control platform.

NK105G2/G3 integrated CNC system is composed of a host system and an operation panel. Also called control box, the host system integrates system control card, terminal board and other parts, and makes connection with the operation panel via a 15-pin extension cable.

The up and down ends at the back of the control box are used to inlay terminals while the left side includes an USB interface and a DB15 interface. The DB15 interface is for connection with the operation panel, while the USB interface for external connection with USB equipment (e.g. USB flash drive).

Also called handheld box, the operation panel is concise and portable, connected with the host system via a 15-pin extension cable, so it can break away from the distribution box and facilitate machine tool control. And its moving distance is only restricted by the length of extension cable.

1.2. Basic Configuration

Basic configuration of NK105G2 system:

NK105G2 handheld box

NK105 three axes control box

Basic configuration of NK105G3 system:

NK105G3 handheld box

NK105 three axes control box

1.3. Mechanical Dimension

The integral thickness of NK105 host system is 218.3mm, with terminals embedded at its up and down ends. Fig. 1-1 is the dimensional drawing and cut-out drawing of NK105G2/G3 control box (unit: mm).

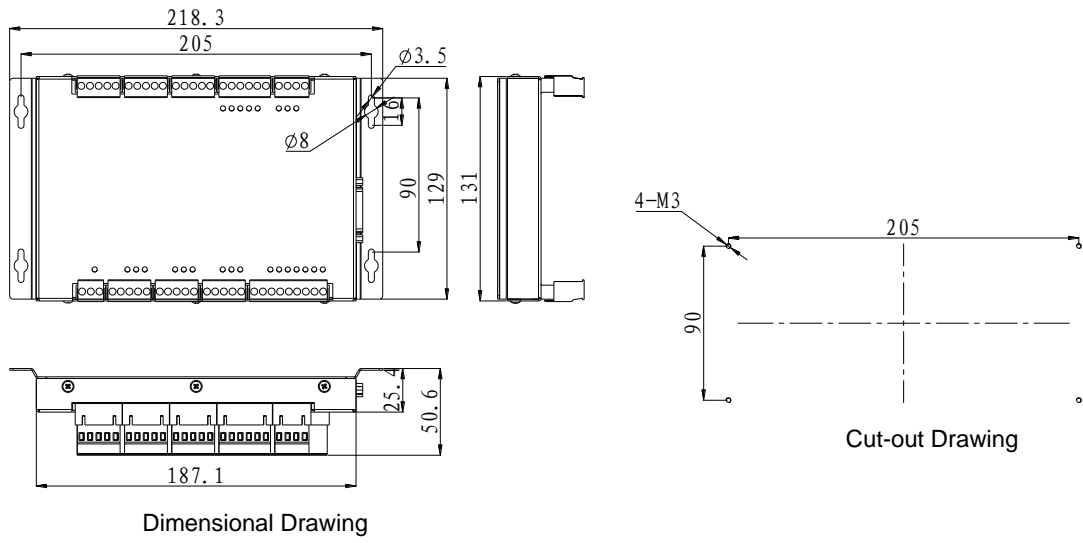

Fig. 1-1 Dimensional drawing and cut-out drawing of NK105G2/G3 control box

2. Wiring Method

2.1. Terminal Specification

2.1.1. Terminal Wiring When General Software Installed

NK105 terminals are inlaid at the up and down ends of the control box. The detailed wiring diagram is as shown in Fig. 2-1, when general software is installed.

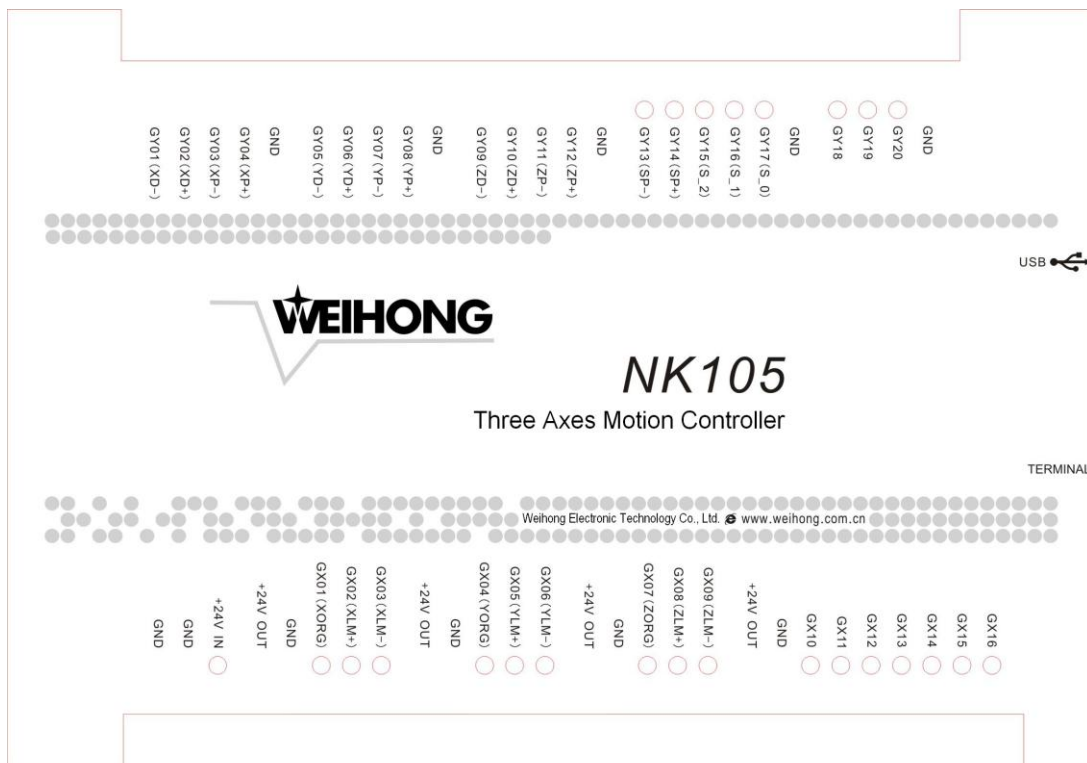

Fig. 2-1 Terminals on NK105 control box

The detailed explanation of terminal pin signals is as shown in Table 1 and Table 2.

Table 1 Output signals

Silk-printed name	Corresponding signal	Remark
GY01(XD-)	Negative differential signal of X-axis direction	XD+ and XD- are differential pair signals of X-axis direction.
GY02(XD+)	Positive differential signal of X-axis direction	
GY03(XP-)	Negative differential signal of X-axis pulse	XP+ and XP- are differential pair signals of X-axis pulse.
GY04(XP+)	Positive differential signal of X-axis pulse	

Silk-printed name	Corresponding signal	Remark
GY05(YD-)	Negative differential signal of Y-axis direction	YD+ and YD- are differential pair signals of Y-axis direction.
GY06(YD+)	Positive differential signal of Y-axis direction	
GY07(YP-)	Negative differential signal of Y-axis pulse	YP+ and YP- are differential pair signals of Y-axis pulse.
GY08(YP+)	Positive differential signal of Y-axis pulse	
GY09(ZD-)	Negative differential signal of Z-axis direction	ZD+ and ZD- are differential pair signals of Z axis direction.
GY10(ZD+)	Positive differential signal of Z-axis direction	
GY11(ZP-)	Negative differential signal of Z-axis pulse	ZP+ and ZP- are differential pair signals of Z-axis pulse.
GY12(ZP+)	Positive differential signal of Z-axis pulse	
GY13(SP-)	Spindle reverse rotation control port	
GY14(SP+)	Spindle forward rotation control port	
GY15(S_2)	2 nd gear output port of spindle speed	Multi-gear spindle speed control ports: they can provide at most 8-gear speed control; in wiring, COM at the inverter end needs joining to the GND terminal.
GY16(S_1)	1 st gear output port of spindle speed	
GY17(S_0)	0 th gear output port of spindle speed	
GY18	Workpiece cooling output port	
GY19	Spindle coolant output port	
GY20	Auto lube output port	
+24V OUT	+24V output	For connection with +24V power supply.

Table 2 Input signals

Silk-printed name	Corresponding signal	Remark
GND	Power GND or COM port	The two GND of the power terminal are connected with power GND and the common ground point of the machine tool respectively, while GND of other terminals can be used as COM signals.

Silk-printed name	Corresponding signal	Remark
+24V IN	+24V DC power input	For external connection with +24V DC power.
GX01(XORG)	Machine origin signal of X-axis	For external connection with mechanical, photoelectric, or proximity switch, etc.
GX02(XLM+)	Positive limit signal of X-axis	
GX03(XLM-)	Negative limit signal of X-axis	
GX04(YORG)	Machine origin signal of Y-axis	
GX05(YLM+)	Positive limit signal of Y-axis	
GX06(YLM-)	Negative limit signal of Y-axis	
GX07(ZORG)	Machine origin signal of Z-axis	
GX08(ZLM+)	Positive limit signal of Z-axis	
GX09(ZLM-)	Negative limit signal of Z-axis	
GX10	Reserved input	
GX11	Reserved input	
GX12	Reserved input	
GX13	Reserved input	
GX14	Reserved input	
GX15	E-stop alarm signal input	
GX16	Tool presetter input	

2.2. Input Interface of +24V Power

The +24V power input interface is for external connection with 24V power. And its pin definition is as shown in Fig. 2-2, in which  is connected to the grounding copper plate of a machine tool, namely to the earth.

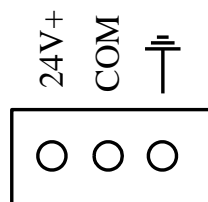

Fig. 2-2 Pin definition of +24V power input interface

2.3. USB Interface

The USB interface is used for externally connecting with USB device (e.g. USB flash drive).

3. Basic Concepts

NK105 system involves various concepts, like workpiece coordinate system (WCS), machine coordinate system (MCS), operation mode, and operation state, etc. You have to grasp these concepts before using NK105.

3.1. Operation Mode and State

3.1.1. Operation Mode

The machine tool is always in one of the following operation modes.

◆ **Auto Mode**

Under automatic operation mode, the machine tool generates motions through the file loaded in advance. Therefore, the machining file must have been loaded.

◆ **Manual Mode**

To meet the requirements of manual motion under different situations, the system provides “Jog” and “Stepping” modes.

- Jog mode: there is no concrete data control under this mode, fit for tuning machine coordinates roughly.
- Stepping mode: this mode is applicable to tuning machining coordinates accurately.

3.1.2. Operation State

The machine tool is also always in one of the following operation states; operation mode and operation state together decide the state of the machine tool.

◆ **IDLE State**

Idle state is the most common state. Under this state, the machine has no motion to output, but is ready to accept any new task.

◆ **ESTOP State**

This is an abnormal state. When there is an error in the hardware of the machine tool, the system will enter into this state and implement the predetermined protection actions, such as closing spindle motor and cooling pump. Under this state, the machine tool is locked and can not carry out any new action.

◆ **Running State**

When the machine tool is implementing any action, the system enters into Running State.

◆ **Pause State**

When the machine tool is running, if the key of “pause during machining” is pressed, the system will enter into PAUSE state and wait for further instruction. At this time, pressing the “Start” key will make the system enter into “Running” state, while pressing the “Stop/Cancel” key will make the system stop.

◆ **LOCK State**

Lock state is an internal state occurring at the time of soft limit operation.

3.2. Coordinate System

Coordinate system is a terminology that is used to describe the motion of a machine tool. For the sake of unification, standard coordinate system adopts the right-hand rule. See Fig. 3-1.

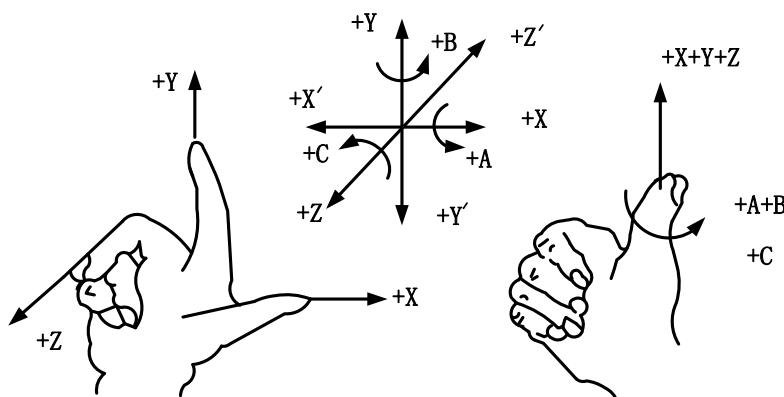

Fig. 3-1 A coordinate system conforming to right-hand rule

For milling machines, the direction of machine axes is decided by both the type of machine tool and the layout of each component. The basic coordinate axes of milling machines are X-axis, Y-axis, and Z-axis:

——Z-axis is coincidental with spindle axis and the direction of the cutter moving away from workpiece is its positive direction (+Z).

——X-axis is perpendicular to Z-axis and parallel to the clamped surface of workpiece. For the single column vertical milling machine, if the user faces the spindle and looks in the column direction, right moving direction is its positive direction (+ X).

——X-axis, Y-axis and Z-axis constitute a coordinate system adhering to the right-hand rule.

3.2.1. Machine Coordinate System

Machine coordinate system is a set of fixed right-hand coordinate system. Its coordinate origin

is always fixed with respect to a certain position on the machine tool. Therefore, at any time, a certain point in space can be exclusively fixed by the machine coordinate system.

The machine coordinate system requires the machine available of the homing function, or this concept will only appear in the software.

3.2.2. Workpiece Coordinate System

As a set of right-hand coordinate system for the programmer, workpiece coordinate system is used in programming. To establish it, the programmer can select a given point on the workpiece as the origin (also called program origin). The origin of workpiece coordinate system (namely the workpiece origin) is fixed with respect to a certain point on the workpiece, while variable with respect to the machine origin. The origin of workpiece coordinate system should be selected meeting such conditions as simple programming, easy dimension conversion and small machining errors.

Workpiece offset corresponds to WCS G54, G55, G56, G57, G58 and G59. After the system is opened, the default WCS is G54, and the relation between workpiece offset and machine coordinate system is as shown in Fig. 3-2.

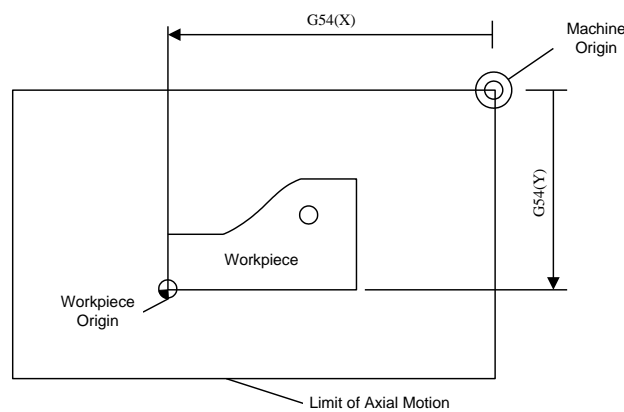

Fig. 3-2 The relation between workpiece offset and machine coordinate system

One, two or several workpiece offsets can be used in one machining program. As shown in Fig. 3-3, three workpieces are installed on the worktable, so each workpiece has a workpiece origin corresponding to the G code of workpiece coordinate system. To drill a hole on each of the workpiece, with calculation depth as Z-0.14, the programming example is as follows.

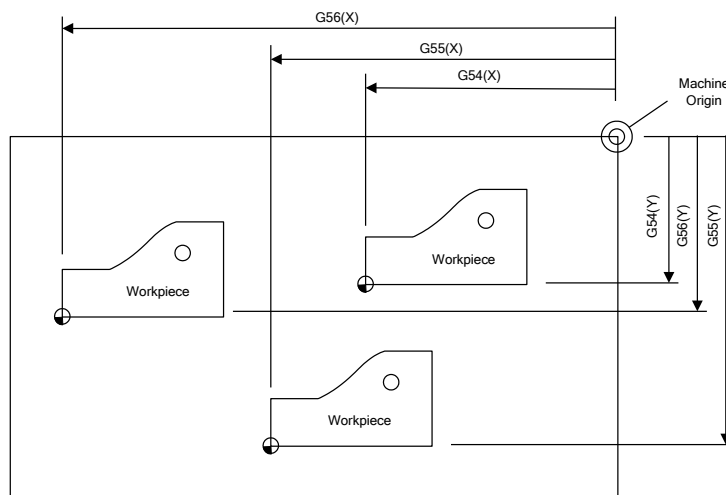

Fig. 3-3 Example figure

```

O1801
N1 G20
N2 G17 G40 G80
N3 G90 G54 G00 X5.5 Y3.1 S1000 M03           (Use G54)
N4 G43 Z0.1 H01 M08
N5 G99 G82 R0.1 Z-0.14 P100 F8.0
N6 G55 X5.5 Y3.1                             (Switch to G55)
N7 G56 X5.5 Y3.1                             (Switch to G56)
N8 G80 Z1.0 M09
N9 G91 G54 G28 Z0 M05                         (Switch to G54)
N10 M01
...

```

Program segments N3~N5 are for the first workpiece, within G54 WCS; program segment N6 drills the hole for the second workpiece of the same batch within G55 WCS; program segment N7 drills the third hole for the third workpiece of the same batch within G56 WCS.

Aiming at all WCSs, public offset is used to adjust the workpiece origin of X, Y and Z axes, without changing the offset value of G54~G59.

Workpiece offset, tool offset and public offset meet the following expression:

$$\text{Workpiece coordinate} = \text{Machine coordinate} - \text{Workpiece offset} - \text{Tool offset} - \text{Public offset}$$

4. Functions & Operation Methods of Panel Keys

4.1. NK105G2 Panel Keys

See Fig. 4-1 for the layout of NK105G2 panel keys.

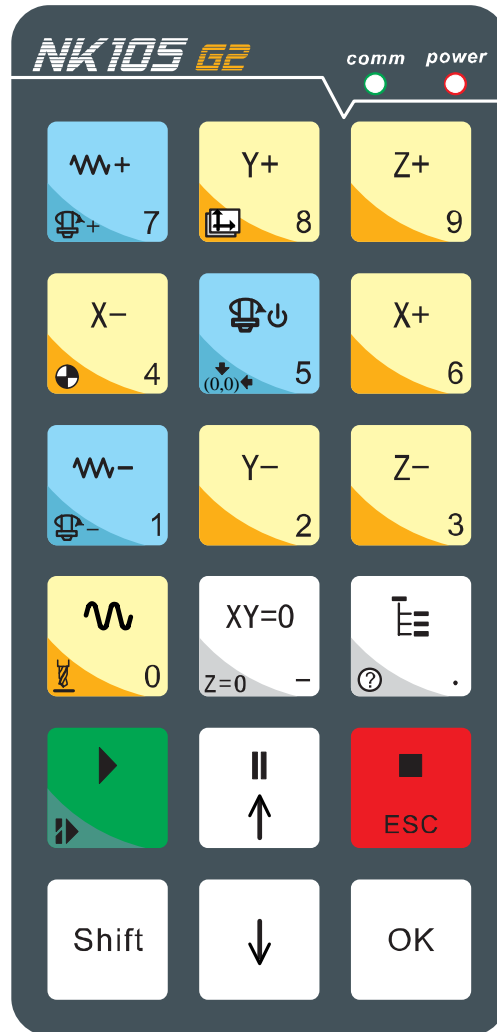

Fig. 4-1 Panel keys of NK105G2

4.1.1. Function Information of Each Single-key

NK105G2 operation panel is both light and concise. With a single-key or combination key, all the operations can be realized. The usage of each single-key is: press a key lightly to complete the called function and then release the key, except that the function of the mode shift key becomes effective when released. See Table 3 for the function information of each single-key.

Table 3 Single-key function table

Key icon	Key name	Function
	Override+	Increase of feedrate override; input of number 7; increase of spindle gear with the help of the auxiliary key when the spindle port has input
	Y+	Positive movement of Y axis; input of number 8; switch between MCS and WCS with the help of the auxiliary key
	Z+	Positive movement of Z axis; input of number 9
	X-	Negative movement of X axis; input of number 4; homing all the axes with the help of the auxiliary key
	Spindle ON/ OFF	Start or stop of spindle under manual mode; input of number 5; backing to workpiece origin with the help of the auxiliary key
	X+	Positive movement of X axis; input of number 6
	Override-	Decrease of feedrate override; input of number 1; decrease of spindle gear with the help of the auxiliary key when the spindle port has input
	Y-	Negative movement of Y axis; input of number 2; first tool measurement with the help of the auxiliary key
	Z-	Negative movement of Z axis; input of number 3; measurement after tool change with the help of the auxiliary key
	Speed switchover	Switchover between jog/rapid jog speed in jog mode; input of number 0; tool measurement with the help of auxiliary key
	Clearing	XY clearing; input of minus; Z clearing with the help of auxiliary key
	Menu	Entering menu page; input of decimal point; entering image update page at the time of system start-up
	Start	Start key; breakpoint resume with the help of the auxiliary key
	Up	Suspend processing; up direction key
	ESC	Stop processing; cancellation of various selections, inputs and operations
	Shift	Auxiliary key; switchover between stepping mode and jog mode under machining page
	Down	Down direction key
	OK	Entering jog/rapid jog speed adjustment page under menu page; confirmation of various selections, inputs and operations

4.1.2. Function Information of Combination Key

The usage of combination key: press the auxiliary key, and then the second; release the two keys simultaneously after the corresponding function called.

Table 4 Combination key function table

Key icon	Function
Shift +	Increase of spindle gear
Shift +	Switchover between WCS and MCS
Shift +	Homing all the axes
Shift +	Backing to workpiece origin
Shift +	Decrease of spindle gear
Shift +	Moveable tool measurement
Shift +	Z clearing
Shift +	Breakpoint resume
Shift +	Entering help page
Shift +	First tool measurement
Shift +	Measurement after tool change
Shift +	Jiggle at pause

4.2. NK105G3 Panel Keys

See Fig. 4-2 for the layout of NK105G3 panel keys.

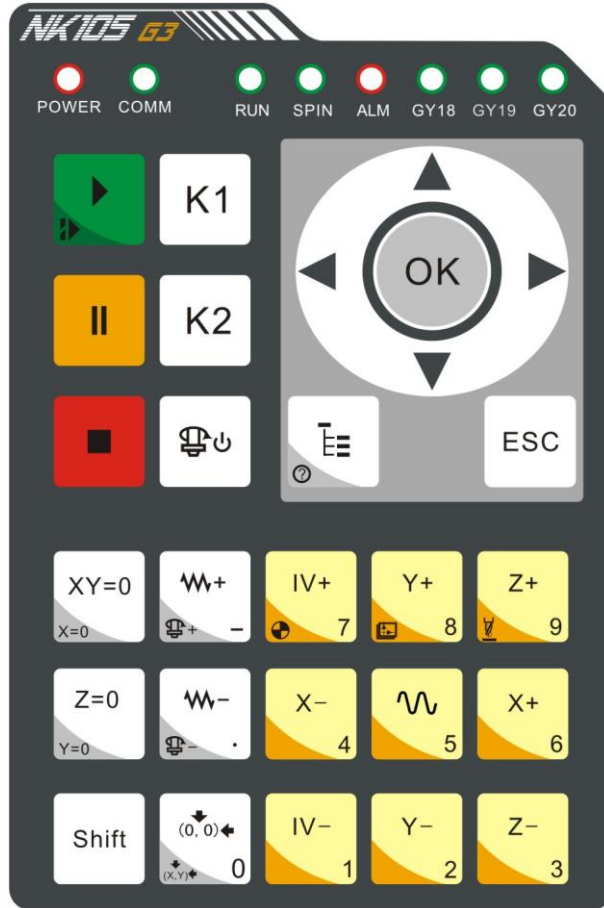

Fig. 4-2 Panel keys of NK105G3

4.2.1. Function Information of Each Single-key

The operation panel of NK105G3 is both light and concise. With a single-key or combination key, all the operations can be realized. The usage of each single-key: press a key lightly to complete the called function and then release the key, except that the function of the mode shift key becomes effective when released. See Table 5 for the function information of each single-key.

Table 5 Single-key function table

Key icon	Key name	Function
	Start	Start key; breakpoint resume with the help of the auxiliary key
	Pause	Pause during machining
	Stop	Stop machining

Key icon	Key name	Function
	Spindle ON/OFF	Start or stop of spindle under manual mode
	Menu	Entering menu page; entering image update page at the time of system start-up; entering help page with the help of the auxiliary key
	ESC	Esc key; returning to the previous page
	XY clearing	XY clearing; X clearing with the help of the auxiliary key
	Z clearing	Z clearing; Y clearing with the help of the auxiliary key
	Shift	Auxiliary key; switchover between stepping mode and jog mode under machining page
	Override+	Increase of feedrate override; increase of spindle gear with the help of the auxiliary key when the spindle port has input
	Override-	Decrease of feedrate override; decrease of spindle gear with the help of the auxiliary key when the spindle port has input
	Back to workpiece origin	XY axes backing to workpiece origin; XY axes backing to fixed point with the help of the auxiliary key; input of number 0
	X-	Negative movement of X axis; input of number 4
	X+	Positive movement of X axis; input of number 6
	Y+	Positive movement of Y axis; input of number 8; switchover between MCS and WCS with the help of the auxiliary key
	Y-	Negative movement of Y axis; input of number 2; first tool measurement with the help of the auxiliary key
	Z+	Positive movement of Z axis; input of number 9; tool measurement executed with the help of the auxiliary key
	Z-	Negative movement of Z axis; input of number 3; measurement after tool change with the help of the auxiliary key
	Speed switchover	Switchover between jog speed and rapid jog speed in jog mode; input of number 5
	Positive	Positive movement of the extended axis; input of number 7; homing all the axes with the help of the auxiliary key
	Negative	Negative movement of the extended axis; input of number 1

4.2.2. Function Information of Combination Key

The usage of combination key: press the auxiliary key, and then the second; release the two keys simultaneously after the corresponding function called.

Table 6 Combination key function table

Key icon	Function
Shift +	Breakpoint resume
Shift +	entering help page
Shift +	X clearing
Shift +	Y clearing
Shift +	Increase of spindle gear
Shift +	Decrease of spindle gear
Shift +	XY axes backing to fixed point
Shift +	homing all the axes
Shift +	Switchover between MCS and WCS
Shift +	Moveable tool measurement
Shift +	Jiggle function
Shift +	First tool measurement
Shift +	Measurement after tool change

4.3. Modification Method of System Parameters

Parameters for modification can be divided into two types:

◆ Input of Numeric Value

After entering the parameter modification page, directly input the desired number, and then press [OK] to save it or press [ESC] to return to the previous page. Only when [OK] is pressed can the modification be saved after parameter modification each time.

For example: the modification method for the parameter “REFP Speed” is as follows.

Speed (mm/min)	
X Axis:	1800.000
Y Axis:	1800.000
Z Axis:	1500.000

Fig. 4-3 Modification page of “REFP Speed”

Press “Menu”→ 5. Mfr Param→ 5. REF. PointSet→ 1. REFP Speed, and then press [OK] to enter the page as shown in Fig. 4-3, and then press the “Up” and “Down” keys to select the axis speed parameter to be modified. When the cursor is on an item, enter the new parameter value directly and then press [OK] to save it.

Note:

If you switch to another parameter without saving the input value during parameter modification, this new value will not be saved and the original value will be restored.

◆ Selection of Parameter Value

Select the parameter value by directly pressing the “UP” or “Down” key.

For example: the modification method for the parameter “REFP Dir” is as follows.

Homing Direction	
X Axis:	Negative
Y Axis:	Positive
Z Axis:	Positive

Fig. 4-4 Modification page of “REFP Dir”

Press “Menu”→ 5. Mfr Param→ 5. REF. PointSet→ 2. REFP Dir, and then press [OK] to enter the page as shown in Fig. 4-4, and then press the “Up” and “Down” keys to select the axis direction parameter to be modified. When the cursor is on an item, press the [OK] key to enter the interface as shown in Fig. 4-5, the arrow indicating the current parameter value. Press [Up] or [Down] key to select the desired parameter value, and then press the [OK] key to confirm the modification.

Direction of X	
•	Positive
▷	Negative

Fig. 4-5 Selection dialog

4.4. System Start-up

The system interface is as shown in Fig. 4-6 after power on.



Booting the system...

Fig. 4-6 System start-up interface

After the system is started, "Back to REF. Point" will be prompted, as shown in Fig. 4-7. Press [ESC] to cancel this operation. You need to adjust the following related parameters sequentially: port polarity (see Chapter 5.3), pulse equivalent (see Chapter 5.1.2), axis output direction (see Chapter 5.1.1) and machine stroke (see Chapter 5.2) before homing all the axes.

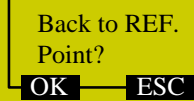

Back to REF.
Point?
OK ESC

Fig. 4-7 Prompt to home all the axes after system started

5. Machine Tool Debugging

5.1. Adjustment of Axis Direction and Pulse Equivalent

5.1.1. Adjustment of Axis Direction

Firstly confirm the positive direction of each axis according to the coordinate system adhering to the right-hand rule before starting machine debugging.

After fixing the positive direction of each axis following the right-hand rule, manually operate the machine to check if the axes move correctly. If the direction is opposite, modify the parameter “Axis OutpDir”. Take X-axis as an example, manually move the X-axis, only to find it moves oppositely. To solve this problem, you just need to change the value of X axis in the parameter “Axis OutpDir” from “Positive (Negative)” to “Negative (Positive)”.

Press the “Menu” key→ 5. Mfr Param→ 2. Axis OutpDir, and then press the [OK] key to enter the interface as shown below.

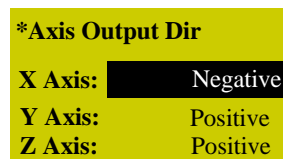

Fig. 5-1 Modification interface of “Axis OutputDir”

Note:

The mark “*” in front of a parameter indicates that the modification to this parameter becomes effective after reboot. Modification to a parameter without the mark becomes effective immediately.

5.1.2. Adjustment of Pulse Equivalent

Pulse equivalent is the moving distance of the worktable or rotation degree of the rotary axis per pulse sent by the CNC device, i.e. the minimum distance controlled by the CNC system. This item can be calculated in terms of information of screw pitch, electronic gear ratio, mechanical deceleration ratio, etc.

The smaller the pulse equivalent is, the higher the machining precision and surface quality will be. At the meanwhile, the setting value of pulse equivalent decides the max. feed speed (feed rate), and the relationship between pulse equivalent and max. feed speed is as shown below:

$$\text{Max. feed speed (mm/min)} = \text{Pulse equivalent (mm/p)} \times \text{Hardware frequency (p/s)} \times 60 \text{ (s/min)}$$

The hardware frequency of NK105G2/G3 is 320KHz; when pulse equivalent is 0.001mm/p, the max. feed speed of machine tool is 19.2m/min.

Lower pulse equivalent should be set under the condition of meeting the demand of feed speed.

◆ **Pulse Equivalent of Linear Axis**

The calculation of pulse equivalent varies with different motor systems.

➤ **Stepping motor**

$$\text{Pulse equivalent} = \frac{\text{Screw pitch}}{\frac{360}{\text{Stepping angle}} \times \text{Subdivision} \times \text{Mechanical deceleration ratio}}$$

Hereinto, mechanical deceleration ratio = rotary speed input in reducer / rotary speed output = teeth number of driven gear / teeth number of driving gear.

For instance, the selected screw lead of X-axis for a certain type machine tool is 5mm, and the stepping angle of stepping motor is 1.8°, with “10” subdivision and “1:1” deceleration ratio. Thus, the pulse equivalent of X-axis is:

$$\text{Pulse Equivalent} = \frac{5\text{mm}}{\frac{360}{1.8} \times 10 \times 1} = 0.0025\text{mm/p}$$

➤ **Servo motor**

$$\text{Electronic gear ratio} \frac{B}{A} = \frac{\text{Encoder resolution}}{\frac{\text{Screw pitch}}{\text{Pulse equivalent}}} \times \text{Mechanical deceleration ratio}$$

Electronic gear ratio: if a servo motor makes one circle per every 5000 pulse commands sent by the system, setting electronic gear ratio of the servo motor can make the servo rotate twice with the same amount of pulse commands (please refer to parameter setting of each servo brand).

Please see the servo motor label plate and then refer to the corresponding manual to confirm its encoder resolution. A label plate of YASKAWA SGMSH type motor is as shown below, and the 4th character in motor type is the serial encoder specification, so the resolution of this motor is 2¹⁷, i.e. 131072.

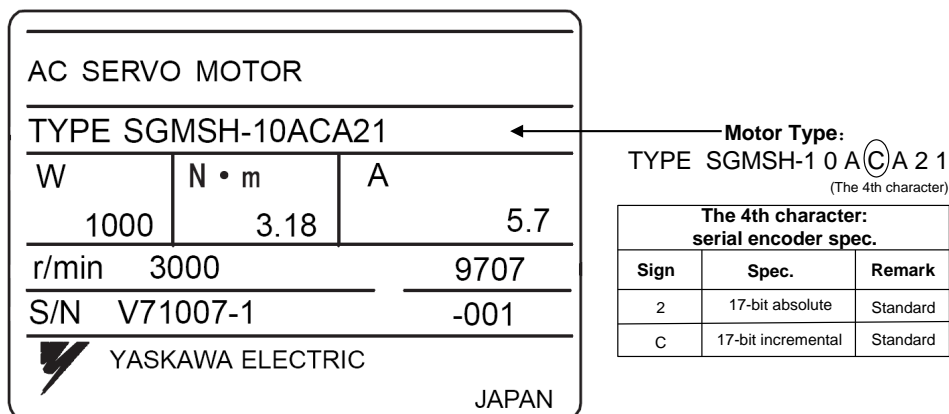

Fig. 5-2 Name plate of servo motor-encoder resolution

For instance: (an example of YASKAWA) the screw pitch of a certain type machine is 5mm, with 17 bit encoder resolution, “0.0001mm/p” pulse equivalent and “1:1” deceleration ratio.

$$\text{Electronic gear ratio} = \frac{PN202}{PN203} = \frac{2^{17}}{5/0.0001} \times 1 = \frac{131072}{5/0.0001} \times 1 = \frac{8192}{3125}$$

◆ Pulse Equivalent of Rotary Axis

The pulse equivalent of rotary axis refers to the rotation degree of the axis clamping the workpiece per pulse. The rotary degree of workpiece per revolution of motor is equal to screw pitch.

➤ Stepping motor

$$\text{Pulse equivalent} = \frac{360}{\frac{360}{\text{Stepping angle}} \times \text{Subdivision} \times \text{Mechanical deceleration ratio}}$$

➤ Servo motor

$$\text{Electronic gear ratio} = \frac{B}{A} = \frac{\text{Encoder resolution} \times \text{Pulse equivalent}}{360} \times \text{Mechanical deceleration ratio}$$

5.2. Setup of Machine Stroke

Machine stroke refers to the valid motion stroke of a machine tool. In the parameter “MachineStrok”, the valid motion range of the three axes (X/Y/Z) can be set. Because this system regards the machine tool dimensions as the reference for soft limit, their values should be consistent with the actual dimensions of the machine tool. Otherwise, limit overrun or axis crash may occur.

If file machining range exceeds the machine tool’s dimensions, there will be a message box prompting machining is out of range, as shown in Fig. 5-3. You can press [OK] or [ESC] to return to the main page, and then manually move the machine tool to release limit.

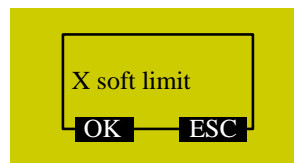

Fig. 5-3 Soft limit prompt

Modification to this parameter becomes valid after system reboot.

5.3. Port Polarity

The polarities of input/ output ports in the software are specified in terms of the switch type: the polarity of a normally closed switch is “P”; the polarity of a normally open switch is “N”. The corresponding relation between system port No. and ports on the terminal board is as shown in Table 7 and Table 8.

The steps to modify port polarity are as following: press “Menu”→ 8. Diagnosis→ 2. Port List, and then press [OK] to enter the interface as shown in Fig. 5-4. At this time, you can press the “Up” or “Down” key to move the cursor to the desired port, and then press the “Shift” key to change its polarity. After its polarity change, press [OK] to save the modification.

IN	GX01	•	P
IN	GX02	○	N
IN	GX03	○	N
IN	GX04	○	N

Fig. 5-4 Modification interface of port polarity

Table 7 Corresponding signals of system input ports

System port No.	Terminal name	Corresponding signal	Remark
0	GX01(XORG)	Machine origin signal of X axis	For external connection with mechanical, photoelectrical or proximity switch.
1	GX02(XLM+)	Positive limit signal of X axis	
2	GX03(XLM-)	Negative limit signal of X axis	
3	GX04(YORG)	Machine origin signal of Y axis	
4	GX05(YLM+)	Positive limit signal of Y axis	
5	GX06(YLM-)	Negative limit signal of Y axis	
6	GX07(ZORG)	Machine origin signal of Z axis	
7	GX08(ZLM+)	Positive limit signal of Z axis	
8	GX09(ZLM-)	Negative limit signal of Z axis	
9	GX10	Extended input	
A	GX11	Extended input	
B	GX12	Extended input	
C	GX13	Extended input	
D	GX14	Extended input	
E	GX15	E-stop alarm signal	External connection with E-stop button on the machine tool
F	GX16	Tool presetter signal	

Table 8 Corresponding signals of system output ports

System port No.	Terminal name	Corresponding signal	Remark
0	GY013(SP-)	Spindle reverse rotation	Multi-gear spindle speed control ports: they can provide at most 8-gear speed control; in wiring, COM at the inverter end needs joining to the GND terminal.
1	GY014(SP+)	Spindle forward rotation	
2	GY15(S_2)	2 nd gear output port of spindle speed	
3	GY16(S_1)	1 st gear output port of spindle speed	
4	GY17(S_0)	0 th gear output port of spindle speed	

System port No.	Terminal name	Corresponding signal	Remark
5	GY18	Workpiece cooling	
6	GY19	Spindle coolant	
7	GY20	Auto lube	

5.4. Back to Machine Origin

Origin of Machine Coordinate System (the inherent coordinate system of a machine tool), also called machine origin, mechanical zero, or home, is fixed after design, manufacturing and debugging before the machine tool leaving factory. Only after backing to machine origin can such operations as soft limit, setting fixed point and tool change be enabled. Therefore, after startup of CNC system, it is necessary to home all the axes. This system will remind to back to machine origin after start-up.

If homing can't be executed due to home switch fault, it is necessary to set the parameter "Back REF First" to "No".

5.4.1. Parameter Setup of Backing to Machine Origin

The parameter "REF. PointSet" includes the setting of "REFP Speed", "REFP Dir" and "Retract Dist".

Press "Menu"→ 5. Mfr Param→ 5. REF. PointSet, and then press the [OK] key to enter the setting interface of backing to machine origin, in which press the "Up" or "Down" key to select the corresponding parameter to be modified.

- "REFP Speed": it is the speed of rough positioning during backing to machine origin, i.e. the motion speed of an axis towards the home switch during rough positioning. The value of this parameter should be set in accordance with the integral structure of a machine tool. And too fast speed can cause missing steps, damage to the machine tool or to the home switch due to axis crash.
- "REFP Dir": it is the direction of rough positioning during backing to machine origin, i.e. the motion direction of an axis towards the home switch during rough positioning. This parameter is decided by the motor direction and installation position of the home switch; at the same time, it is also related with the defined attribute of the input level and the attribute of the home switch.
- "Retract Dist": this parameter is decided by the machine tool itself. After arriving at the machine origin, the machine tool will move some distance away from the machine origin to get out of the signal sensitive zone of the home switch. Its value is recommended as half of the screw pitch.

5.4.2. Operation Mode of Backing to Machine origin

After system start-up, pressing [OK] in the dialog box shown in Fig. 5-5 will home all the axes.

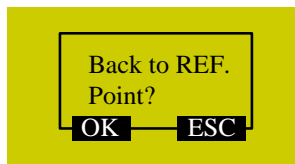

Fig. 5-5 Prompt dialog box of backing to machine origin

This method can only home all the axes. If you want to execute single axis backing to machine origin, refer to the following steps.

Press the “Menu” key→ 3. Operations→ 1. Back REF Point, and then press the [OK] key to enter the setup interface of backing to machine origin, in which press the “Up” or “Down” key to select the desired mode. And then press the [OK] key to execute backing to machine origin in the selected way. It is recommended to execute “Z Home” firstly. If “X Home” or “Y Home” is executed firstly, a message as shown below will be displayed on the LCD prompting to execute “Z Home” firstly. To see all the information, press the “Up” and “Down” keys.

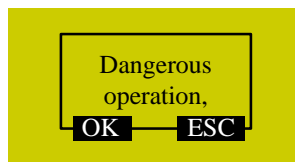

Fig. 5-6 Dangerous prompt for operation of backing to machine origin

At this time, you can press the [OK] key to enter the machining page and execute backing to machine origin for the selected axis, or press [ESC] to cancel and return to the previous page.

5.5. Spindle Debugging

This system can control spindle motor through parameters of “Spindle Gears”, “ON/OFF Delay”, “Initial Gear” and “Max. Spdl Speed”. Spindle speed can also be changed during machining under the condition that the interface board and inverter have been well connected.

5.5.1. Spindle Setup

Press the “Menu” key→ 5. Mfr Param→ 6. Spindle Set, and then press the [OK] key to enter the spindle setup interface, in which press the “Up” or “Down” key to select the corresponding parameter for modification.

◆ Spindle Gears

Currently, 8 gears are supported.

◆ ON/OFF Delay

Since it takes some time for the spindle to reach the rated rotary speed or stop completely, tool damage or a scrap may happen if machining starts before the spindle reaching the rated rotary

speed or other actions are performed before the spindle stopping completely. This parameter set the delay time for the spindle to reach the set spindle speed or stop completely when turned ON or OFF.

◆ Initial Gear

It sets the default gear when the spindle started, and its value should be smaller than the total gear number of the spindle. Otherwise, the input value is invalid. If the input value of “Spindle Gears” is smaller than that of “Initial Gear”, the setup is not effective, either.

Modification to this parameter becomes effective after reboot.

◆ Max. Spdl Speed

It refers to the max. rotary speed of the spindle; its value is consistent with the setting of inverter.

Modification to this parameter becomes effective after reboot.

5.5.2. Park MCS Site

Press the “Menu” key→ 3. Operations→ 5. Park MCS Site, and then press the [OK] key to enter the interface of “Park Mode” and “Park Site”, as shown in Fig. 5-7. The position of the spindle after the end of machining can be set here.

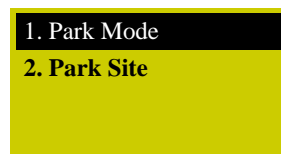

Fig. 5-7 Park MCS site interface

Select “Park Mode”, and then press [OK] to enter the interface as shown below.



Fig. 5-8 Park mode selection

Press the “Up” or “Down” key to select the desired item, and then press the [OK] key to accomplish the selection and return to the previous page. If “To park site” is selected and confirmed, input or select the park site under “2. Park Site”.

After selecting “Select Site”, press the [OK] key, and then press [OK] again to set current position as the park position. The system will then back to the main page automatically. At this time, you can press the “Start” key to start machining directly.

Note: current position cannot be set under “Select Site”; you need to set the current position of the spindle in advance.

5.5.3. Spindle Stop

Press the “Menu” key→ 4. Oper Param→ 10. SpindleStop, and then press the [OK] key to enter the setting interface of “Spindle Stop”, in which press the “Up” or “Down” key to select the corresponding parameter for modification. See Fig. 5-9 for the three modes of spindle stop.

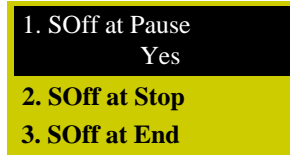

Fig. 5-9 Spindle stop setting interface

5.6. Manual Machining

Manual machining refers to manipulating a machine tool by the direction keys of the three axes on the panel. At the same time, the operation speed and step length, etc. can also be adjusted according to the requirements of operation.

After backing to the reference point, the system will enter into the manual state automatically, the screen display as shown in Fig. 5-10.

1X	0.000	Idle
1Y	0.000	SOff
1Z	0.000	Slow
Jog		100%

Fig. 5-10 Manual machining interface

Note:

Chapters 5.6, 5.7 and 5.8 are the machining operations of NK105G2, while Chapter 7 introduces the machining operations of NK105G3 in details.

5.6.1. Mode Selection of Manual Machining

To satisfy the requirements of manual motion under different situations, this system provides two kinds of manual motion modes: “Jog” and “Stepping”, which can be switched by pressing the “Shift” key. The current motion mode is displayed at the bottom of the LCD.

◆ Jog Motion Mode

There is no concrete data control under this mode. You can press an axis direction key ( 6,

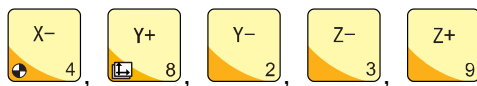







) to move the machine tool accordingly under this mode. The

machine tool will not stop until the direction key is released. For the motion speed, it is decided by the current type of speed (jog speed and rapid jog speed). This motion mode is suitable for coarse tuning of the position of machine coordinate.

◆ Stepping Motion Mode

Under this motion mode, the machine tool will move accordingly after an axis direction key

(, , , , , ) is pressed. This motion mode is suitable for fine tuning of the position of machine coordinate.

5.6.2. Parameter Setting of Manual Machining

Basic parameters of manual machining include: rapid jog speed (i.e. “High” shown in the machining page), jog speed (i.e. “Slow” shown in the machining page), XY step and Z step.

Table 9 Parameters for manual machining

Parameter	Meaning	Setting range
MSpd (High)	Two types of speed under manual machining, deciding the axis motion speed during manual machining.	0.06~Max. speed of machine tool
MSpd (Slow)		0.06~Rapid jog speed
Step XYZ	The motion distance of the corresponding axis each time an axis direction key of X/Y/Z is pressed.	0.001~10000mm

The max. speed of a machine tool is related with the setting of pulse equivalent. For the concrete expression, see Chapter 5.1.2.

Jog speed (Slow) and rapid jog speed (High) are switched by pressing .

The concept of stepping (also called gridding in some other systems) is introduced for the accuracy of machining and debugging. When the system is in the stepping mode, step is the motion distance of the corresponding axis each time an axis direction key of X/Y/Z is pressed.

Under the main page, press the [OK] key to enter the parameter setting page of manual machining, as shown in Fig. 5-11.

MSpd	3000/ 1500
StepXY	10.000
StepZ	1.000
File	<FLOWER.G>

Fig. 5-11 Manual parameter setting page

Press “Up” or “Down” to select the desired parameter, and then press [OK] for confirmation after modification. Note that modification should be within the parameter range.

Current file name is displayed at the bottom of the LCD. Press “Up” or “Down” to move the

cursor to the file name, and then press [OK] to enter the file list of C disk, as shown in Fig. 5-12. You can only load these files, unable to delete or copy them under this page.



Fig. 5-12 File list page

If there is no file in the C disk, the prompt “File Not Found, Show USB File?” will be displayed; press [OK] to enter the file list of USB flash drive.

To switch between USB file list and C file list, press .

5.7. Automatic Machining

Automatic machining refers to that the system processes system files and the files in the USB flash drive in terms of instructions, also called file machining. All the parameters of the machine tool and the system should be set correctly before automatic machining starts.

5.7.1. Load File

◆ Load an Ordinary File

Press “Menu” to enter the menu page→ press the “Up” and “Down” keys to select “Local Files” or “USB Files”→ press [OK] to enter the corresponding file list page→ press [OK] to select the

desired machining file→ press to load the selected file.

◆ Load an ENG File with Tool Selection Function

Find the desired ENG file following the steps above-mentioned to load an ordinary file, and then

press [OK] to select the ENG file to be machined, and then press to automatically enter the tool selection page as shown in Fig. 5-13.

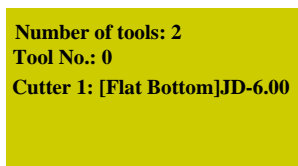

Fig. 5-13 Tool selection page



Number of tools: the number of tools in this ENG file

Tool No.: current tool No., selected by pressing the “Up” and “Down” keys

Cutter: selected by pressing the “Up” and “Down” keys, displaying tool sequence number and name

After parameters are set, press [OK] to load the file; after loading, the system will return to the machining page automatically.

5.7.2. WCS Selection

WCS and MCS are switched by pressing the combination key  + . And their screen display is as shown in Fig. 5-14.

X	0.000	Idle	1X	0.000	Idle
Y	0.000	SOff	1Y	0.000	SOff
Z	0.000	Slow	1Z	0.000	Slow
Jog		100%	Jog		100%

MCS WCS

Fig. 5-14 Screen display of WCS and MCS

Number 1~6 in front of X/Y/Z in WCS indicates G54~G59 respectively, while there is no number before X/Y/Z in MCS. A sign * will appear after each axis in MCS after the completion of backing to machine origin.

Press the “Menu” key→ 3. Operations→ 6. Select WCS, and then press [OK] to enter the setup page, in which press the “Up” and “Down” keys to select the desired WCS. After selection, the contents in the main page will change accordingly. For instance, after “G55 WCS” is selected, the number in front of each axis will change to 2, as shown in Fig. 5-15.

2X	0.000	Idle
2Y	0.000	SOff
2Z	0.000	Slow
Jog		100%



Fig. 5-15 Main page under WCS G55



5.7.3. Set Workpiece Origin

Workpiece origin is the zero of X, Y, and Z in the machining file. Before machining, you must set workpiece origin to determine its actual position.

Manually move the X and Y axes to the desired origin position, and then press  for XY clearing, i.e. to confirm the position of XY workpiece origin.

For Z workpiece origin, there are two ways to set it:

➤ Method one is the same as that to set XY workpiece origin. Manually move the Z axis to the desired origin position. And then press  +  for Z clearing, i.e. to confirm the position of Z workpiece origin.

➤ Method two takes advantages of tool measurement. Press  +  to execute moveable tool measurement. After measurement completed, the coordinate of Z axis is Z workpiece origin.



5.7.4. Start Machining

Press the start key  to start automatic machining in the machining page.

Prompts like feedrate override and feed rate are scrolled on the LCD during file machining.



5.8. Adjustment during Automatic Machining

5.8.1. Feedrate Override Adjustment





Feedrate override can be increased or decreased by pressing  or  during file machining. And the feed rate changes with the feedrate override. The relation between actual feed rate and feedrate override is as follows:

$$\text{Actual feed rate} = \text{Feed rate} \times \text{Feedrate override}$$

The least unit of feedrate override is 0.1. Namely, override increases (decreases) by 0.1 after

each press of  or ; at the same time, the feedrate override displayed on the LCD increases (decreases) by 10%. The range of feedrate override is within 0%~120%. In addition, the display of feed rate value changes with the feedrate override.



5.8.2. Spindle Speed Adjustment

Spindle speed are adjusted by pressing  +  or  + , and divided into 8 gears from S0~S7 with speed increasing sequentially.

5.8.3. Machining Pause and Jiggle

If machining is found not in position exactly, suspend the machining and then execute manual jiggle. Suspend machining by pressing the “Pause” key in machining, “Paus” displayed at the top right corner of the LCD while the machine tool stopping moving; as for the spindle, whether it stops or not is decided by the setting of the parameter “SOff at Pause”. Whether the spindle stops or not, at this time, the three axes can be jigged, and the system is in “Stepping” mode by default. Each press of an axis direction key will make the corresponding axis move a specified step.

The operation steps as follows:

- 1) Press  in the process of machining, and then press  +  to enter the jiggle page.
- 2) Press “↑” or “↓” to select a step size from “0.01”, “0.02”, “0.05”, “0.10”, “0.20”, “0.50” and “1.00”.
- 3) Press one of “4”, “6”, “2”, “8”, “3” and “9” to execute jiggle on the desired axis in the corresponding direction.
- 4) Press “Start” to resume machining after jiggle.

Note: if hard limit, soft limit or E-stop occurs in jiggle, the system will stop jiggle, give a limit prompt or an alarm, and return to the main page.

5.8.4. Continuing Machining after Pause

When the system is in the state of pause, pressing the start key  will continue machining from the pause position, running status at the top right corner of the screen changing from “Paus” to “Run”; at the same time, the machine tool continues machining.

5.8.5. Soft Limit Handling

Soft limit occurs when an axis exceeds the setting range of “MachineStroke” during machining, and the system will display a limit dialog as shown below.

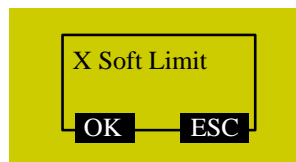

Fig. 5-16 Soft limit dialog

Press [OK] or [ESC] to exit from this warning dialog and return to the machining page, and then manually move the limit axis towards the reverse direction to release limit. After soft limit occurs, the

system prohibits the limit axis from moving towards the limit direction.

5.8.6. Hard Limit Handling

The system detects hard limit periodically under the main page. When hard limit occurs, its prompt dialog is as shown in Fig. 5-17.

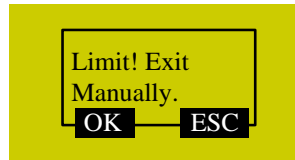

Fig. 5-17 Hard limit dialog

At this time, press [OK] to return to the main page under “Jog” mode, with “Limit Rls.” displayed at the bottom right corner of the LCD, as shown in Fig. 5-18. Or you can press [ESC] to directly back to the main page under “Jog” mode.

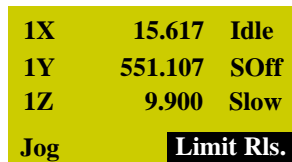

Fig. 5-18 Prompt interface of limit release

Move the machine tool away from the limit position, “Limit Rls.” disappearing. The main page returns to its normal state.

6. Menu Page

6.1. Summarization

After start-up, the system is in manual mode and machining page by default. The machining page displays info like coordinate axes, coordinate value, operation state, spindle state, type of manual speed and machining mode. See Fig. 6-1.

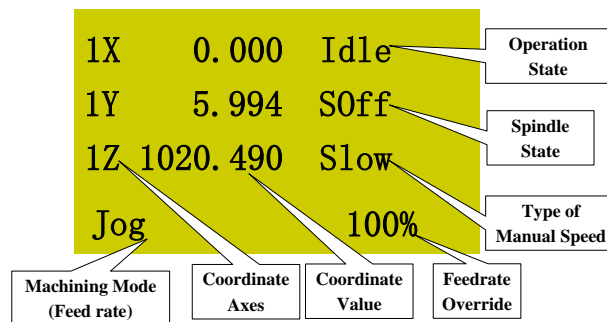

Fig. 6-1 Machining page

◆ Machining Mode

It is comprised of jog and stepping modes, which can be switched by pressing



◆ Coordinate Axes

Machine coordinate system (MCS) and workpiece coordinate system (WCS) are included, and

are switched by pressing the combination key + . The system in Fig. 6-1 is in WCS, and the number 1~6 before X/Y/Z axis indicates WCS from G54 to G59 respectively. For MCS, there is no number before X/Y/Z axis. After homing is accomplished, a sign * will be displayed after the corresponding axis in MCS.

◆ Operation State

Operation state includes idle, E-stop, running, pause and lock states.

◆ Spindle State

It indicates the current spindle gear and spindle ON/OFF. In idle state, spindle is turned ON or

OFF by pressing . In machining state, spindle gear is increased or decreased by pressing

+ or + . 1S represents the 1st-gear rotary speed, 2S the 2nd-gear rotary speed, and nS the nth-gear rotary speed.

Note:

For NK105G3, in idle state, spindle is turned ON or OFF by pressing ; in machining state, spindle gear is increased or decreased by pressing + or + .

◆ Type of Manual Speed

Manual speed is divided into two types: rapid jog speed (High) and jog speed (Slow), which are

switched by pressing . Refer to Chapter 5.6.2 for the speed setting method.

Note:

For NK105G3, rapid jog speed and jog speed are switched by pressing .

◆ Menu Page

Press to enter the menu page. There are altogether 8 parameter items in the menu but the LCD can only show 4 of them at a time, as shown in Fig. 6-2.

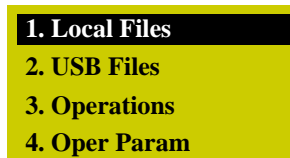

Fig. 6-2 Menu page

Press “Up” and “Down” keys to select the desired item and then press [OK] key to enter the corresponding sub-menu.

6.2. Local Files/ USB Files

Local file list page or USB file list page is as shown in Fig. 6-3, in which load, delete or copy can be executed. Only one file can be loaded to the system at a time. If several files are selected at the same time, a prompt dialog will appear in loading.

Note:



After the Z- key is pressed to execute “③Copy”, a dialog box will pop up asking for confirmation; press [OK] to start copying; if the file is large, the system page will display “Copy Progress...”; wait patiently and do not press any key on the operation panel until copy completed.

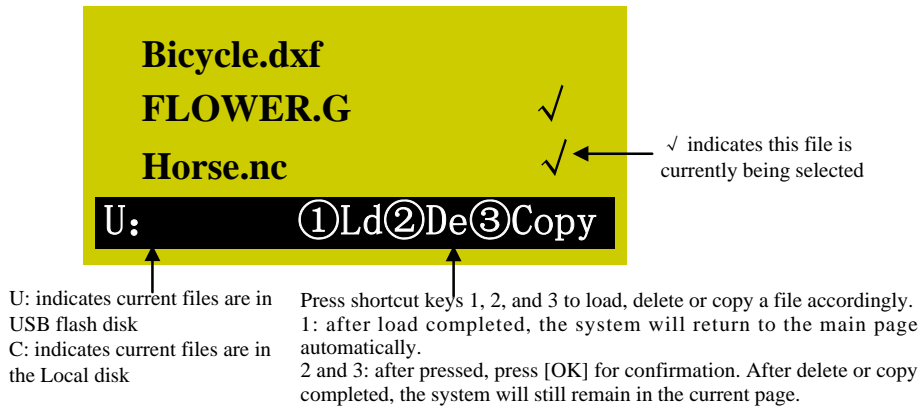

Fig. 6-3 File list page

6.3. Operations

The sub-menus under [Operations] are as shown in Fig. 6-4.

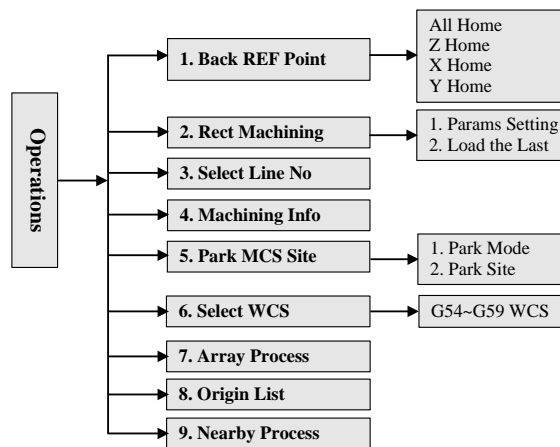

Fig. 6-4 Submenus under [Operations]

Press the “Menu” key→3. Operations, and then press [OK] to enter its page, in which select the desired menu item by the “Up” or “Down” key. Fig. 6-5 is the [Operations] page.

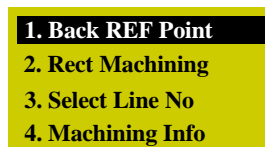

Fig. 6-5 [Operations] page

6.3.1. Back REF Point

For details, see Chapter 5.4.

6.3.2. Rect Machining

The system offers rectangle milling wizard; after setting parameters successfully, press the “Up” and “Down” keys to select [Load Now], and then press [OK] to load the machining file; and then you

can press  to start machining.

You can also select “2. Load the Last”, and then press [OK] to load the last rectangle milling and return to the machining page, and then press  to start machining.

Parameters “X Init” and “Y Init” decide the initial position of machining plane; “Height” and “Width” decides the size of machining plane; two kinds of machining mode are available: “Horiz. Mill” (the feed direction of tool is parallel to X axis) and “Long. Mill” (the feed direction of tool is parallel to Y axis); “EachDpth” is the tool machining depth each time; generally, the value of “EngrDpth” (the total depth of several millings) is set bigger than that of “EachDpth”; if the value of “EachDpth” is equal to or bigger than that of “EngrDpth”, only one milling will finish the machining; “NoseGap” means the distance between two adjacent lines, whose value should be set smaller than that of “ToolDia” to avoid missing millings.

Note:

1. After setting parameters and moving the cursor to “Load Now”, you still need to press [OK] to load the machining file.
2. If the input value of “EngrDpth” is too big, the system will send the warning information “Too many file layers generated, continue?”, as shown in Fig. 6-6. You can press [ESC] to back to modify the value; or press [OK] to load the file anyway, the system staying in the page shown in Fig. 6-6. At this time, if you press a key, its function will not be executed until this dialog box disappears, so it is not allowed to press any key under this state. You can wait patiently until the file is successfully loaded, or you can power off and re-power on the system.

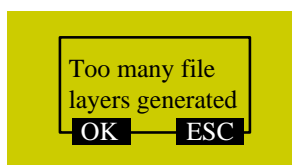

Fig. 6-6 Warning dialog when parameters not properly set

6.3.3. Select Line No

This page shows the loaded file information, like total line No., start line No. and end line No. The default setting of “StartLine” is the breakpoint position of the current file, and “EndLine” the last line. With this function, you can select any blocks to be processed. After these values are set, press the “Up” or “Down” key to select “Execute Now”, and then press [OK] to start machining instantly.

Note:

The default line No. of "StartLine" is the breakpoint line No. under this page.

6.3.4. Machining Info

After this item is selected and [OK] is pressed, the system will analyze the file currently loaded automatically, like calculating the needed time for file machining and the machining range of each axis. The page of analytic result is as shown in Fig. 6-7.

Time:	0:	1:	42
X :	108	205	
Y :	20	117	
Z :	0	5	

Fig. 6-7 Analytic result of machining

6.3.5. Park MCS Site

For details, refer to Chapter 5.5.2.

6.3.6. Select WCS

Press "Menu"→ 3. Operations→ 6. Select WCS, and then press [OK] to enter the page shown in Fig. 6-8, displaying the 6 WCSs from G54 to G59.

G54 WCS
G55 WCS
G56 WCS
Select by [OK] key

Fig. 6-8 WCS selection page

After pressing the "Up" and "Down" keys to select the corresponding WCS, press [OK] to confirm the selection. After confirmation, the number before X/Y/Z axis will change accordingly, WCSs of G54~G59 corresponding to 1~6 respectively.

6.3.7. Array Process

Array machining (array process), i.e. array machining of graphics, is available in NK105G2/G3. After selecting a file and specifying rows, columns and row/ column space, press "Load Now" to generate and load the array file. Before starting machining, you can turn to "Machining Info" under "Operations" to see the machining range of the array file.

Operation steps as follows:

Menu→ Operations→ Array Process→ Load the desired single-workpiece machining file, and set parameters like Rows, Columns, RowSpace, ColSpace and Delay→ Select Load Now and press OK→ Press Start to start array machining. The array file generated can be found under the source

file path.

Note:

1. This function is only available for tool path files of text format, like txt, nc and u00.
2. Codes, like G92, M17 and G65, and #variables, like #1 and #2, cannot appear in the tool path file.
3. Codes, like M30, M2 and M1, when included in the tool path file, will be removed automatically from the newly generated array file.
4. Call of a sub-program in the PUBLIC is not allowed in the tool path file.

6.3.8. Origin List

Press “Menu”→ 3. Operations→ 8. Origin List, and then press [OK] to enter the origin list page.

To save workpiece origin, the operation steps are as follows:

If the current position is desired to save as workpiece origin, press the corresponding shortcut key to set it as workpiece origin→ turn to the origin list page→ move the cursor to one of the 8 items and press “OK”→ press the number key “1” to save the current position as workpiece origin.

Note:

Before saving, loading or deleting workpiece origin in the origin list page, press “OK” to confirm the selected item.

The number key 1 is for saving workpiece origin, 2 for loading, and 3 for deleting. If workpiece origin saved in one of the 8 items is loaded, it will be set as the current workpiece origin.

6.3.9. Nearby Process

NK105G2/G3 supports machining from proximal point. In case of insufficient machining, you can manually move the spindle nearby, and then execute “Nearby Process” to resume machining from the machining point nearest to the current spindle position.

6.4. Oper Param (Operator Parameters)

◆ Parameters Related with Velocity

Parameter	Meaning	Setting range
G00 Speed	G00 speed, which can be set in this parameter or in the program file	Related with the specific machine tool G00 speed < Max. velocity of machine tool
Gxx Speed	Gxx speed	Related with the specific machine tool
Ratio ON Manu	Whether manual operations affected by feedrate override	Yes: Affected No: Not affected

The max. velocity of a machine tool is related with the setting of pulse equivalent. For the detailed expression, see Chapter 5.1.2.

The relation between actual feed rate and feedrate override is:
Actual feed rate= Feed rate × Feedrate override

Parameter	Meaning	Setting range
	Jog speed and rapid jog speed are set in the manual speed setup page; G00 speed \geq machining speed, and rapid jog speed \geq jog speed > 0.06	

◆ Parameters Related with Machining

Parameter	Meaning	Setting range
Back REF First	Whether homing all the axes before machining required or not	Yes: Required No: Not required
Lifts on Pause	Lifting amount at pause	0~10000 mm
CycleProcess		
Cycle Process	Whether to enable cycle process	Yes: Enabled No: Disabled
Cycle Times	Cycle machining times, valid when "Cycle Process" is set to "Yes"	1~9999
Cycle Interval	Interval between two adjacent cycles	0~3600000
S_Off in Intev	Whether to stop spindle in the interval	Yes: Stop No: Not stop
G73_G83Retract	Retract or spacing amount of G73_G83 command	0~1000000 mm
Homing all the axes before machining can prevent machining deviation and ensure position accuracy. It is recommended to set "Back REF First" to "Yes" to disable a machine tool to run automatically if backing to machine origin is not executed before machining. When the home switch cannot work normally, "Back REF First" can be set to "No". G73_G83Retract: the retract amount after each feed under G73 command; under G83 command, the distance between the feed plane where the cutter changes from G00 to Gxx and the previous peck depth.		

◆ Parameters Related with Offset

Parameter	Meaning	Setting range
PublicOffset	Aiming at all the WCSs, used for adjusting workpiece origin of X, Y and Z axes	-10000~10000 mm
Work Offset	D-value of WCS origin and MCS origin	-10000~10000 mm
The relation of workpiece offset, tool offset and public offset is as following: Workpiece coordinate = Machine coordinate - Workpiece offset – Tool offset – Public offset		

◆ Spindle Parameters

Parameter	Meaning	Setting range
SpindleStop		
SOff at pause	Whether to stop spindle at pause	Yes: Stop; No: Not stop
SOff at Stop	Whether to stop spindle at stop	Yes: Stop; No: Not stop
SOff at End	Whether to stop spindle when machining completed	Yes: Stop; No: Not stop
ProcessEndTip	Whether to turn on the red light indicator as a sign of the completion of machining	Yes: On; No: Off
This group of parameters sets whether to stop spindle under various forms of stop state.		

◆ File Parameters

Parameter	Meaning	Setting range
Dxf Params		
Lifting Height	It sets the tool lifting height of Z axis during rapid traverse when a DXF file is being processed.	0~99999 mm
Process Depth	It specifies the machining depth for 2D files.	-99999~0 mm
1st Point as 0	It sets whether to set the first point as workpiece origin when a DXF file is processed.	Yes: Valid; No: Invalid
Shape Process	The system will not process the next shape until the current shape is finished.	Yes: Valid; No: Invalid
Bottom Process	Valve operation is enabled only when [3D cutting] is on the workpiece surface.	Yes: Valid; No: Invalid
Metric Size	It forcibly sets a dxf file using metric size.	Yes: Metric size No: Imperial size
Eng Params		
Lifting Height	It sets the tool lifting height of Z axis during rapid traverse when an ENG file is being processed.	0~99999 mm
ToolChangeTip	It sets whether to pause and prompt tool change when tool change command is encountered during ENG file machining.	Yes: Valid; No: Invalid
Cycle Times	It sets the cycle times to process an Eng file.	0~100000
Deep Hole Mode	Mode selection for deep hole machining	0: Reciprocating chip removal 1: High-speed reciprocating chip removal
Retract Amount	Retract amount after each feed in high-speed reciprocating chip removal mode	0~99999999 mm
Select ToolNo.	If this parameter is set to "Yes", the machining will be executed in terms of the specified tool No. in the machining file and only this file will be processed.	Yes: Valid; No: Invalid
Plt Params		
Lifting Height	It sets the tool lifting height of Z axis during rapid traverse when a PLT file is being processed.	0~99999 mm
Plt Unit	Normally, 1plt=40.195mm, which can be enlarged or diminished by setting this parameter.	0.001~99999
Tool step	The value should be confirmed in terms of the tool diameter and make the adjacent tool paths overlap for a full machining.	0.0001~99999 mm
Processing Depth	It specifies the machining depth for 2D files.	-99999~0 mm
DXF parameters are for the translation of DXF files. In DXF file machining, the system treats the action of tool lifting as the separate mark for the adjacent shapes, If there is no tool lifting, the system		

Parameter	Meaning	Setting range
	will consider only one shape is being processed. If tool lifting occurs, it indicates the machining of a complete shape is finished. For example, process several circles adjacent to each other. The depth of each circle is 10mm, and each feed depth of Z axis is 2mm. If the parameter "Shape Process" is set to "Yes", the machine tool will process the current circle 5 times, and then lift the tool, and then go to process the next circle. If it is set to "No", the machine tool will process the current circle once, then lift the tool, and then go to process the next circle. After all the circles are processed once, this process will be re-executed 4 times to finish machining all the shapes.	
	ENG parameters are for the translation of ENG files.	
	PLT parameters are for the translation of PLT files. PLT is a format of 2D machining files defined by an American company—Hewlett Packard (HP), usually used in embossment and advertising carving. At the same time, PLT is also a kind of unit. Normally, 1plt=40.195mm, which can be enlarged or diminished by setting the parameter "PLT Unit".	

◆ Tool Change Parameters

Parameter	Meaning	Setting range
Tool Change		
ATC Capacity	Capacity of tool magazine	1~20
Current ToolNo.	Tool No. currently used	1~Value of ATC Capacity
Tool Offset	Modification to the tool offset along each axis	X/Y/Z: -10000~10000 mm
ToolChangeTip	Whether to send prompt when there is tool change command in the file	Yes: Valid; No: Invalid
X/Y/Z Cali Coor	The machine coordinate (X/Y/Z) of tool presetter in fixed tool measurement	/
CaliToolHeigh	The required tool lifting height after the end of tool measurement	0.001~9999 mm

◆ Ignore Command

Parameter	Meaning	Setting range
Ignore F Code	Whether to enable the feedrate command in the machining file	Yes: Enable the feed rate in the system No: Enable the feed rate in the machining file
Ignore S Code	Whether to enable the spindle command in the machining file	Yes: Enable the spindle command in the system No: Enable the spindle command in the machining file

6.5. Mfr Param (Manufacturer Parameters)

◆ Velocity Parameters

Parameter	Meaning	Setting range
Decel. Dist.	To protect tools, the machine tool will decelerate (at [Approach Speed]) when approaching the	0~999mm

Parameter	Meaning	Setting range
	target position during positioning. This parameter is used to specify the distance from the decelerating position to the target position.	
Approach Speed	It is the feed speed of the tool when approaching workpiece during positioning (the distance between the tool and workpiece is smaller than deceleration distance).	Jump speed ~ Machining speed
Sgl Axis Acc.	Description of the acceleration/ deceleration capability of each feed axis, in "mm/s ² "	0.001~100000.0mm/s ²
Max. Turn Acc.	The max. acceleration of feed motion on adjacent axes	0.001~100000.0 mm/s ²
Jerk	The change rate of acceleration of single axis (acceleration's acceleration)	0.001~100000.0 mm/s ³
Max. Speed of Z	It specifies the max. speed of Z axis.	0.06~100000.0 mm/min
ShortSegSpdLmt	Whether to enable speed limit for short segments	Yes: Valid; No: Invalid
SpdLmt Length	The max. length of short segments	0.001~100000mm
Z Down Option	The mode of Z axis downward cut	0: Not disposed 1: Only Z axis 2: XYZ synchronization
Z PlungeCutSpd	The downward cut speed of Z axis under G01 downward cut	0~Max. Speed of Z axis
Ref Cir Radius	See below for explanation.	0.001~100000.0 mm
Ref Cir. Speed	Reference circle is the reference for the machining of circular workpiece. The max. speed of reference circle refers to the max. speed of machine in machining this circle without obvious vibration.	Min. speed of arc machining ~ Machining speed
Jump Speed	The max. speed for the stepper motor at start-up without acceleration	[Approach Speed]~Machining speed
<p>After the installation of a machine tool, you can make the machine process a circle, in which vibration will occur due to centrifugal force. The higher the speed is, the stronger the vibration will be. Gradually increase the feed speed to see the state of vibration of the machine tool until the max. circular speed is achieved, i.e. the max. speed of the machine tool without strong vibration. This circle is regarded as the reference circle, and its max. speed is the max. speed of reference circle. Max. centripetal acceleration "a" can be calculated in terms of the reference circle radius and its max speed. The formula is as follows: V_0 and R_0 are the speed and radius of the reference circle respectively, while V_x and R_x are the speed and radius of an arc to be processed. After R_x is confirmed, when the arc machining speed is larger than V_x calculated, the system will limit the arc machining speed automatically to ensure it is within the debugging value, i.e. the vibration will not be stronger than that during ex-factory debugging.</p> $a = \frac{V_0^2}{R_0} = \frac{V_x^2}{R_x}$		

◆ Parameters Related with Machine Tool Debugging

Parameter	Meaning	Setting range
Axis OutpDir	The motion direction of each axis	Positive; Negative
MachineStroke	The valid motion stroke of a machine tool, i.e. the valid machining range of a machine tool in X/Y/Z axis	Set according to the actual machine tool
Pulse Equiv.	The worktable stroke per pulse sent by the CNC device or the rotary degree of a rotary axis, i.e. the least distance the CNC system can control	0.00009~999.0 mm/p
REF. PointSet		
REFP Speed	The speed of rough positioning in backing to machine origin	0.001~Max. speed of machine tool
REFP Dir	The direction of rough positioning in backing to machine origin	Positive; Negative
Retract Dist	The additional motion distance after fine positioning stage in backing to machine origin, to move out of the machine origin signal sensitive zone	0~10000 mm
Sign of BK REF	Whether to eliminate the sign of backing to machine origin after E-stop	Yes: Eliminate No: Not eliminate

Note:

If you can ensure that the axis position will not deviate after E-stop, you can set the parameter "Sign of BK REF" to "No", so you can continue machining without backing to machine origin after E-stop is obviated. Otherwise, you need to set this parameter to "Yes" to ensure machining accuracy.

◆ Spindle Parameters

Parameter	Meaning	Setting range
Spindle Set		
Spindle Gears	Spindle speed is divided into several gears.	1~8
ON/OFF Delay	The wait time for the spindle to reach normal rotary speed or stop completely after turned ON or OFF	0~60000 ms
Initial Gear	Initial speed gear	1~[Spindle Gears]
Max. Spdl Speed	Max. spindle speed	Spindle speed~999999 mm/min

◆ Y Rotaryaxis

Parameter	Meaning	Setting range
Y AsRotaryAxis	Whether Y axis is set as rotary axis	Yes: Valid; No: Invalid
Rotary Y Pulse	The pulse equivalent of Y axis when it is set as rotary axis	0~100 mm/p
mm As Unit	It sets the measure unit for the rotary axis.	Yes: in mm

Parameter	Meaning	Setting range
		No: in deg
Rev. WorkRadius	The length of Y axis in CAM programming is the value of workpiece radius $\times 2 \times \pi$. The value of this parameter changes with the radius of workpiece.	0~1000000mm
Rotary Takeoff	The takeoff speed of the rotary axis	0~1000000 mm/s
Rotary Y Acc.	The acceleration of the rotary axis, with unit as rad/s^2	0.001~100000.0 rad/s^2
Max. RotaryVel.	Max. rotary speed	0.06~6000000 r/min

◆ **Lubrication Setting**

Parameter	Meaning	Setting range
Lube		
EnableAutoLube	Whether to open lubrication pump automatically at fixed period	Yes: Valid No: Invalid
Time Interval	Time interval between two adjacent lubes	0~34560000 s
Duration	Duration time to release lubrication oil each time	0~34560000 s

◆ **Parameters Related with Algorithm**

Parameter	Meaning	Setting range
Enable S Algo	Whether to adopt S-type algorithm	Yes: Valid; No: Invalid
Arc Increment	Whether to adopt arc increment mode In arc increment mode, the coordinates of the circle centre are relative to the starting point. Otherwise, they are relative to workpiece origin.	Yes: Valid; No: Invalid
Forward LookSeg	Used to set the max. look-ahead segments when calculating connection speed	0~10000
ARadiuToleranc	In the IJK incremental representation of G02 and G03, the circle radius is calculated twice. Generally, the two values calculated are not the same and their D-value is called arc radius tolerance. Typically, arc instruction does not incur too large tolerance, and the recommended value is about 0.01mm.	0.001~Max. speed of machine tool
Look Ahead Dis	The system looks ahead a certain distance to analyze and calculate path interpolation.	0~999mm

Note:

The parameter "Look Ahead Dis" is only available in NK105G3.

◆ Compensation Parameters

Parameter	Meaning	Setting range
Backlash Set		
CompensationON	Whether to enable backlash compensation	Yes: Valid; No: Invalid
AxisBacklash	The backlash compensation amount of X, Y and Z axes, valid only when “CompensationOn” is set to “Yes”	0~1000000 mm
Generally, the spindle is secured to a screw whose outer wire and inner wire on the outer wire can not be completely matched, backlash compensation compensates the clearance between the screw of last direction that the spindle needs to finish after reversing its moving direction.		

◆ Other Operations

Parameter	Meaning	Setting range
Smoothing Time	The larger the value is, the smoother the workpiece surface will be, but too large a value will affect the dimension of workpiece. 0.01 is recommended for a mold machine, and 0.03 for a woodworking machine.	0.0~0.064 ms
G00 Feed 100%	Whether to enable 100% feedrate override for G00	Yes: Valid; No: Invalid
Safety Height	Calculated with respect to workpiece origin. The horizontal movement at this height is considered to be safe, used in breakpoint resume and backing to workpiece origin.	0~5000 mm
CalibThickness	The thickness of the tool presetter	0~Worktable range
Corner Option	The type of corner smooth	0: Not disposed 1: Curve 2: Arc
Corner Toler	For the integral smoothness of workpiece, the tool may not arrive at the specified position accurately at the connection of each two program segments. When the difference between the tool position and the specified position is equal to the value of this parameter, the system regards the end of the current program segment machining.	0.0~0.1
Setting Contro	Whether to enable 1.5ms control cycle	Yes: Enable No: Disable

6.6. Param Upkeep (Parameter Maintenance)

Press the “Menu” key→ 6. Param Upkeep, and then press [OK] to enter the page, in which select a submenu by pressing the “Up” and “Down” keys.

The submenus under this page are as shown in Fig. 6-9.

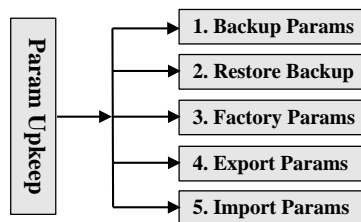

Fig. 6-9 Submenu list of parameter upkeep

6.6.1. Backup Params

Press [OK] to confirm backing up the parameters. No matter whether the parameter backup is successful or failed, a prompt will be displayed.

6.6.2. Restore Backup

It is used to restore the backup parameters. If the parameters have not been backed up, “Backup File Not Found!” will be displayed.

If the recovery is successful, a prompt of rebooting the system will be displayed, as shown in Fig. 6-10. At this time, you can press [OK] to reboot the system directly, or [ESC] to return to the previous page.

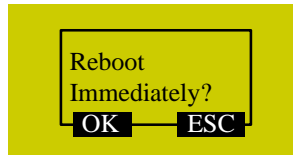

Fig. 6-10 Prompt dialog of system reboot

6.6.3. Factory Params

The action of ex-factory parameter recovery is to clear all the data and parameters interiorly set stored in the system memory chip. It is necessary to perform this action when there are messy codes in the interior file or after upgrade finishes.

Operate following the prompts displayed on the screen. After recovery is successful, a cue to reboot the system will be displayed on the screen, as shown in Fig. 6-10. At this time, you can press [OK] to restart the system, or [ESC] to back to the previous page.

The action of ex-factory parameter recovery won't clear the parameters backup file. Therefore, if this action is carried out accidentally and all the interior parameters are cleared, you can restore the backup parameters by “Restore Backup”.

Note:

Modification to this item will not become effective until the system is rebooted.

6.6.4. Export Parameters

When software or hardware fault occurs, you can export parameters to an USB flash drive for backup.

6.6.5. Import Parameters

Import the parameters in the USB flash drive to the system, avoiding repeatedly setting parameters. After import is successful, the system will display a prompt of system reboot as shown in Fig. 6-11.

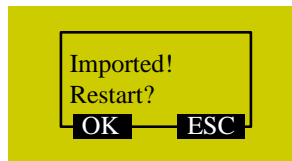

Fig. 6-11 Prompt dialog of successful parameter import

6.7. System Upkeep

Press "Menu"→ 7. System Upkeep, and then press [OK] to enter its page, in which select a submenu by pressing the "Up" and "Down" keys.

The submenus under this page are as shown in Fig. 6-12.

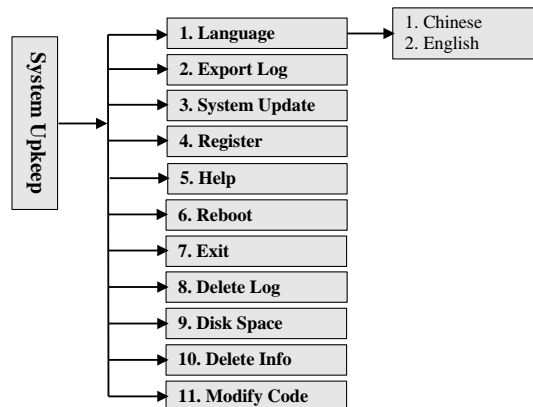

Fig. 6-12 Submenu list of system upkeep

6.7.1. Language

Currently, the system supports two kinds of language: Chinese and English, which can be switched in the following page.



Fig. 6-13 Chinese-English selection page

6.7.2. Export Log

A Log.txt will be generated after the log is exported to an USB flash drive. After log export finishes, “Log Exported Successfully” will be displayed on the screen. Press [OK] or [ESC] to return to the previous page.

6.7.3. System Update

After the cursor is on the “System Update” item, press [OK] for confirmation, after which a dialog will pop up asking whether to update the system. After [OK] is pressed again, a dialog as shown in Fig. 6-14 will pop up.

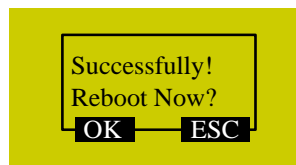

Fig. 6-14 Prompt dialog after successful system update

Press [OK] to reboot the system. After the system displays “USB Available Now!”, press [OK] to enter the system update page, as shown in Fig. 6-15.

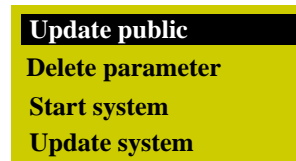

Fig. 6-15 System update page

Select a corresponding operation in this page by pressing the “Up” and “Down” keys. “Update public” is to update the Public.dat file; “Delete parameter” is to delete the configuration file in BOOT, which must be executed before “Update system”; “Start system” is to start the original system without upgrading it; “Update system” means deleting the original system and upgrading the system by the new application file in the USB flash drive. Refer to Chapter 8 for the details of system update.

At this time, you can select “Start system” and then press [OK] to exit from system update page, or select “Update system” and then press [OK] to exit from system update page and enter the machining page by booting the new system.

◆ Export Backup

The software will be exported to the USB flash drive for backup, with its backup folder named “backup”.

◆ Import Parameter

This menu item is used to import the parameter file (file name: settings.dat) in the USB flash drive into the system. Generally, the parameter file is under the root directory of the USB flash drive. If it is not in the root directory, search for it in the “backup” folder.

◆ Version number

It is used to view the version number of BOOT loader.

6.7.4. Register

Move the cursor to “4. Register”, and then press [OK] to enter registration code input page, as shown in Fig. 6-16.

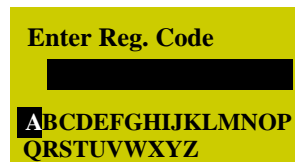

Fig. 6-16 Registration code input page

Register by entering the registration code in this page. Select a letter (end-around) by pressing the “Up” and “Down” keys, and then press [OK] for conformation; for the input of a number, press the corresponding number key.

6.7.5. Help

After the cursor is on the item “5. Help”, press [OK] to enter the “Help Message Show Delay” parameter setting page as shown in Fig. 6-17. The value of this parameter is an integer within the range of 1~999999.

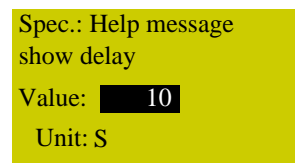

Fig. 6-17 Help setting page

6.7.6. Reboot

After the cursor is on this item, press [OK] to eject its dialog box asking “Sure To Reboot System”, press [OK] to reboot the system.

6.7.7. Exit

After the cursor is on this item, pressing [OK] will eject a dialog box, in which pressing [OK] will exit from the system. And then the LCD goes blank. If you want to enter the system again, you need

to power off and re-power the system.

6.7.8. Delete Log

After the cursor is on this item, pressing [OK] will eject a dialog box, in which pressing [OK] will delete the system log.

6.7.9. Disk Space

The menu item is used for viewing the capacity and used space of the system disk.

6.7.10. Delete Info

This menu item is used for clearing temporary files in the system to release space.

6.7.11. Modify Code

This menu item is used for changing manufacturer password.

6.8. Diagnosis

Press “Menu”→ 8. Diagnosis, and then press [OK] to enter its page, in which select a submenu by pressing the “Up” the “Down” keys.

The submenus under this page are as shown in Fig. 6-18.

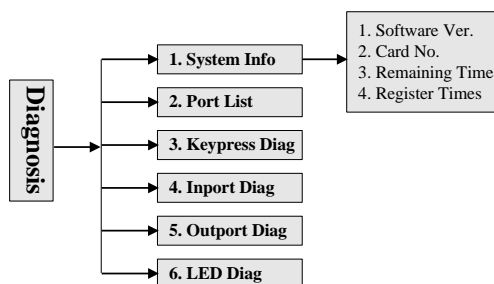

Fig. 6-18 Submenu list of system diagnosis

Note:

LED diagnosis is only available in NK105G3.

6.8.1. System Info

In this page, you can view the software version, control card No., remaining time and registered times. If an item is wrong, after pressing [OK] for confirmation, an error prompt “Failed to Read Registration Info” will be displayed. At the same time, the other items can not be read, either.

6.8.2. Ports List

For details, see Chapter 5.3.

6.8.3. Keypress Diag

This menu item is used to check whether panel keys work normally. After entering the test page, the system will display a prompt “Press a key”. Pressing any key at this time will show the name of the pressed key on the screen, as shown in Fig. 6-19. If the pressed key is damaged and out of work, the screen will not display its name or the wrong key name. Pressing “ESC” will exit from this page.

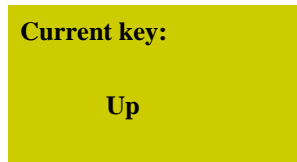

Fig. 6-19 Keypress diagnosis page

6.8.4. Inport Diag

This page is only for viewing the polarities of the input ports, instead of changing them.

6.8.5. Outport Diag

This page is only for viewing the polarities of the output ports displayed by running lights, instead of changing them. The corresponding relation among system output terminal No., terminal board ports and signals is listed in Chapter 5.3 Port Polarity.

6.8.6. LED Diag

This page is only for checking the work conditions of the LEDs on the NK105G3 handheld box. In the LED diagnosis page, press F1. If the LEDs work regularly, all the LEDs become light.

7. Machining Operations of NK105G3

7.1. Manual Machining

Manual machining refers to manipulating a machine tool by the direction keys of the three axes on the panel. At the same time, the operation speed and step length, etc. can also be adjusted according to the requirements of operation.

After backing to the reference point, the system will enter into the manual state automatically, the screen display as shown in Fig. 7-1.







1X	0.000	Idle
1Y	0.000	SOff
1Z	0.000	Slow
Jog		100%

Fig. 7-1 Manual machining interface







7.1.1. Mode Selection of Manual Machining

To satisfy the requirements of manual motion under different situations, this system provides two kinds of manual motion modes: “Jog” and “Stepping”, which can be switched by pressing the “Shift” key. The current motion mode is displayed at the bottom of the LCD. For the setup of step, jog speed and rapid jog speed, press [OK] under the machining page to enter the setup interface.

◆ Jog Motion Mode

There is no concrete data control under this mode. You can press an axis direction key (, , , , , ) to move the machine tool accordingly under this mode. The machine tool will not stop until the direction key is released. For the motion speed, it is decided by the current type of speed (jog speed and rapid jog speed). This motion mode is suitable for coarse tuning of the position of machine coordinate.

◆ Stepping Motion Mode

Under this motion mode, the machine tool will move accordingly after an axis direction key is pressed (, , , , , ). Each time an axis direction key is pressed down, the machine tool will move the set step in the corresponding direction. This motion mode is suitable for fine tuning of the position of machine coordinate.

7.1.2. Parameter Setting of Manual Machining

Basic parameters of manual machining include: rapid jog speed (i.e. “High” shown in the machining page), jog speed (i.e. “Slow” shown in the machining page), XY step and Z step.

Parameter	Meaning	Setting range
MSpd (High)	Two types of speed under manual machining, deciding the axis motion speed during manual machining.	0.06~Max. speed of machine tool
MSpd (Slow)		0.06~Rapid jog speed
Step XYZ	The motion distance of the corresponding axis each time an axis direction key of X/Y/Z is pressed.	0.001~10000mm

Jog speed (Slow) and rapid jog speed (High) are switched by pressing .

The concept of stepping (also called gridding in some other systems) is introduced for the accuracy of machining and debugging. When the system is in the stepping mode, step is the motion distance of the corresponding axis each time an axis direction key of X/Y/Z is pressed.

Under the main page, press the [OK] key to enter the parameter setting page of manual machining, as shown in Fig. 7-2.

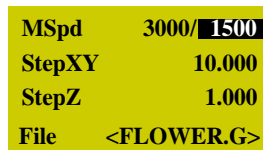

Fig. 7-2 Manual parameter setting page

Press “Up” or “Down” to select the desired parameter, and then press [OK] for confirmation after modification. Note that modification should be within the parameter range.

Current file name is displayed at the bottom of the LCD. Press “Up” or “Down” to move the cursor to the file name, and then press [OK] to enter the file list of C disk, as shown in Fig. 7-3. You can only load these files, unable to delete or copy them under this page.



Fig. 7-3 File list page

If there is no file in the C disk, the prompt “File Not Found, Show USB File?” will be displayed; press [OK] to enter the file list of USB flash drive.

To switch between USB file list and C file list, press .

7.2. Automatic Machining

Automatic machining refers to that the system processes system files and the files in the USB

flash drive in terms of instructions, also called file machining. All the parameters of machine tool and system should be set correctly before automatic machining starts.

7.2.1. Load File

◆ Load an Ordinary File

Press “Menu” to enter the menu page→ press the “Up” and “Down” keys to select “Local Files” or “USB Files”→ press [OK] to enter the corresponding file list page→ press [OK] to select the

desired machining file→ press  to load the selected file.

◆ Load an ENG File with Tool Selection Function

Find the desired ENG file following the steps above-mentioned to load an ordinary file, and then press [OK] to select the ENG file to be machined, and then press  to automatically enter the tool selection page as shown in Fig. 7-4.

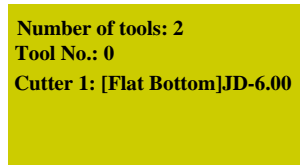

Fig. 7-4 Tool selection page



Number of tools: the number of tools in this ENG file

Tool No.: current tool No., selected by pressing the “Up” and “Down” keys

Cutter: selected by pressing the “Up” and “Down” keys, displaying tool sequence number and name

After parameters are set, press [OK] to load the file; after loading, the system will return to the machining page automatically.

7.2.2. WCS Selection

WCS and MCS are switched by pressing the combination key  + . And their screen display is as shown in Fig. 7-5.

X	0.000	Idle
Y	0.000	SOff
Z	0.000	Slow
Jog		100%

MCS

1X	0.000	Idle
1Y	0.000	SOff
1Z	0.000	Slow
Jog		100%

WCS

Fig. 7-5 Screen display of WCS and MCS

Number 1~6 in front of X/Y/Z in WCS indicates G54~G59 respectively, while there is no number

before X/Y/Z in MCS. A sign * will appear after each axis in MCS after the completion of backing to machine origin.





Press the “Menu” key → 3. Operations → 6. Select WCS, and then press [OK] to enter the setup page, in which press the “Up” and “Down” keys to select the desired WCS. After selection, the contents in the main page will change accordingly. For instance, after “G55 WCS” is selected, the number in front of each axis will change to 2, as shown in Fig. 7-6.

2X	0.000	Idle
2Y	0.000	SOff
2Z	0.000	Slow
Jog	100%	

Fig. 7-6 Main page under WCS G55



7.2.3. Set Workpiece Origin

Workpiece origin is the zero of X, Y, and Z in the machining file. Before machining, you must set workpiece origin to determine its actual position.

Manually move the X and Y axes to the desired origin position, and then press  for XY clearing, i.e. to confirm the position of XY workpiece origin. You can also press  +  and  +  to execute X clearing and Y clearing separately.

For Z workpiece origin, there are two ways to set it:

➤ Method one is the same as that to set XY workpiece origin. Manually move the Z axis to the desired origin position. And then press  for Z clearing, i.e. to confirm the position of Z workpiece origin.

➤ Method two takes advantages of tool measurement. Press  +  to execute mobile tool measurement. After measurement completed, the coordinate of Z axis is Z workpiece origin.



7.2.4. Start Machining

Press the start key  to start automatic machining in the machining page.



Prompts like feedrate override and feed rate are scrolled on the LCD during file machining.

7.3. Adjustment during Automatic Machining





7.3.1. Feedrate Override Adjustment

Feedrate override can be increased or decreased by pressing  or  during file machining. And the feed rate changes with the feedrate override. The relation between actual feed rate and feedrate override is as follows:

$$\text{Actual feed rate} = \text{Feed rate} \times \text{Feedrate override}$$

The least unit of feedrate override is 0.1. Namely, override increases (decreases) by 0.1 after each press of  or ; at the same time, the feedrate override displayed on the LCD increases (decreases) by 10%. The range of feedrate override is within 0%~120%. In addition, the display of feed rate value changes with the feedrate override.



7.3.2. Spindle Speed Adjustment

Spindle speed are adjusted by pressing  +  or  + , and divided into 8 gears from S0~S7 with speed increasing sequentially.

7.3.3. Machining Pause and Jiggle

If machining is found not in position exactly, suspend the machining and then execute manual jiggle. Suspend machining by pressing the “Pause” key in machining, “Paus” displayed at the top right corner of the LCD while the machine tool stopping moving; as for the spindle, whether it stops or not is decided by the setting of the parameter “SOff at Pause”. Whether the spindle stops or not, at this time, the three axes can be jigged, and the system is in “Stepping” mode by default. Each press of an axis direction key will make the corresponding axis move a specified step.

The operation steps as follows:

- 1) Press  in the process of machining, and then press  +  to enter the jiggle page.
- 2) Press “↑” or “↓” to select a step size from “0.01”, “0.02”, “0.05”, “0.10”, “0.20”, “0.50” and “1.00”.
- 3) Press one of “4”, “6”, “2”, “8”, “3” and “9” to execute jiggle on the desired axis in the corresponding direction.
- 4) Press “Start” to resume machining after jiggle.

Note: if hard limit, soft limit or E-stop occurs in jiggle, the system will stop jiggle, give a limit prompt or an alarm, and return to the main page.

7.3.4. Soft Limit Handling

Soft limit occurs when an axis exceeds the setting range of “MachineStroke” during machining, and the system will display a limit dialog as shown below.

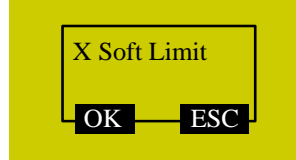

Fig. 7-7 Soft limit dialog

Press [OK] or [ESC] to exit from this warning dialog and return to the machining page, and then manually move the limit axis towards the reverse direction to release limit. After soft limit occurs, the system prohibits the limit axis from moving towards the limit direction.

7.3.5. Hard Limit Handling

The system detects hard limit periodically under the main page. When hard limit occurs, its prompt dialog is as shown in Fig. 7-8.

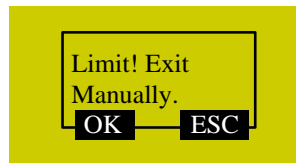

Fig. 7-8 Hard limit dialog

At this time, press [OK] to return to the main page under “Jog” mode, with “Limit Rls.” displayed at the bottom right corner of the LCD, as shown in Fig. 7-9. Or you can press [ESC] to directly back to the main page under “Jog” mode.

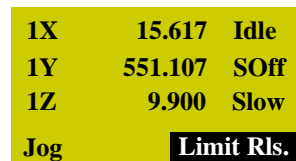



Fig. 7-9 Prompt interface of limit release

Move the machine tool away from the limit position, “Limit Rls.” disappearing. The main page returns to its normal state.

7.3.6. E-stop Handling

When E-stop occurs, the system will stop machining, and give an alarm as shown in Fig. 7-10, the “ALM” indicator on the panel ON. Before executing any other operations, remove this alarm by turning the E-stop button clockwise.

After E-stop alarm is removed, home all the axes, and then press  +  to execute breakpoint resume, i.e. to resume machining from the stop position when E-stop occurs.

1X	15.617	Estp
1Y	551.107	SOff
1Z	9.900	Slow
Jog		ESTOP2

Fig. 7-10 E-stop alarm

Note:

In E-stop state, all the other keys are invalid except the “Menu” key. You can press the “Menu” key to enter the menu page and make desired changes.

8. System Update

NK105G2/G3 can be used directly since the software has already been well installed before delivered. In case of breakdown, update the system.

8.1. Software Update

Software update is included in the process of system image update. If there is no need updating the system image, directly update the software following the below steps:

- 1) Store the software application to be updated under the root directory of an USB flash drive, and then insert the USB flash drive into the USB interface of NK105 control box. (The software application is composed of five file folders—"CHN", "Config", "ENG", "Font", and "NewNK200", which should all be under the root directory of the USB flash drive)
- 2) Power on NK105, press "Shift" to enter the menu page, select "7. System Upkeep" and "3. System Update" in turn, and operate according to the tips on the LCD until "USB Available Now!" appears. Press "OK" to enter the system update interface, and then select "Delete parameter". After parameter files are deleted, select "Update system" to start updating the software. After update completed, the new software will be rebooted automatically.

Note:

Parameters should be restored to factory setting after each software update, unless the update software is totally the same as the old software (e.g. the same version). If "Delete parameter" is not selected in the process of update, it is a must to restore ex-factory parameters after software updated by following the below steps: after the system is rebooted, press "Shift" to enter the menu page; and then select "6. Param Upkeep" and "3. Factory Params" sequentially, and then operate according to the tips on the LCD.

8.2. System Mirror Update

- 1) Store the system image (NK105.nb0) and the software application to be updated under the root directory of an USB flash drive (above 1G), and then insert the USB flash drive into the USB interface of the NK105 control box. (The software application is composed of five file folders—"CHN", "Config", "ENG", "Font", and "NewNK200", which should all be under the root directory of the USB flash drive)
- 2) Power on NK105, and then long press the "Menu" key  until entering the update selection interface. Press "1" to select "1: Update menu", and then press 3 to select "3: OS" in the new pop-up page to start updating the system image.
- 3) Note that this process is a little long, about 3 minutes. After completed, "USB Available Now!" will be displayed on the LCD. Press "OK" to enter the system update interface, and then select "Update system" to start updating the software. After update completed, the new system will be rebooted automatically.

The steps of EBOOT and FPGA update are similar to those of image update. The file for FPGA update is fpga105.dat, while that for EBOOT update is EBOOT.nb0. They should also be placed under the root directory of an USB flash drive. After entering the update selection interface and pressing “1” (“1: Update menu”), you can start FPGA update by pressing “1” (“1: FPGA”), or EBOOT update by pressing “2” (“2: EBOOT”).

Note:

Since image update clears all the old files, it is strongly recommended to do backup before image update.

9. Driver

9.1. Driver parameters

Driver parameters listed in this chapter can only make a machine tool motion normally, without ensuring machining effects. To get a better machining result, you need to read through the servo driver documentation of the corresponding brand and change the parameter setting according to the specific machine tool.

9.1.1. Parameter Setting of YASKAWA Σ -II Servo Driver

Para. No.	Function	Value	Description
Fn010	Set password (to prevent arbitrarily modification to parameters)	0000	Set [0000]: modification to user parameters [PnXXX] and part of auxiliary function parameters [FnXXX] permitted; Set [0001]: modification to user parameters [PnXXX] and part of auxiliary function parameters [FnXXX] prohibited.
Un00C	Pulse counter of input command	LXXXX (Hexadecimal system)	Monitor if the number of sent and received pulse is correct by setting this parameter. In Weihong control system, the correct quantity of pulse sent by control card is detected by pulse inspection in order to determine whether there is electrical interference.
Pn000	Direction selection Control mode selection	0010	Bit 0: Set 0, "CCW" is forward rotation (viewed from the load end of screw ball); Set 1, the rotation direction of the motor is reversed. Bit 1: Set 1, position control mode (calculate pulse instruction all the time).
Pn200	Select pulse instruction mode	0005	Bit 0: Set 5, select the instruction input mode as "pulse + direction", negative logic. Bit 3: Set 0, input differential signal into filter.
Pn50A	Selection function	8100	Bit 1: Set 0, Servo ON /S-ON, input from 40th pin; Set 7, Servo ON all the time. Bit 3: Set 8, positive rotation not used and signal input (P-OT) prohibited.
Pn50B	Selection function	6548	Bit 0: Set 8, reverse rotation not used and signal input (N-OT) prohibited.
Pn50F	Selection function	0300	Set it when servo motor with brakes. Bit 2: Set 3, brake interlock signal "/BK" is output from CN1-29, CN1-30 to control 24V relay for brake

Para. No.	Function	Value	Description		
Pn50E	Selection function	0211	Set it when servo motor with brakes To avoid of CN1-29 and CN1-30 being used for other function and leading to brake ineffective, "3" is not allowed to appear in the 4 digits.		
Pn506	Servo off, time delay of brake when motor stops	Depended	Set it when motor with brakes Default setting is "0", setting unit is 10ms.		
Pn201	Encoder cycle-divided ratio (Pulse output No. per motor cycle by encoder after cycle-divided)	Right-side	Gain Encoder	Type	Encoder Pulse No. per Motor Circle (pulses/ revolution)
				A	13bit 2048
				B	16bit 16384
				C	17bit 32768
Pn202	Electronic gear ratio (numerator)	Need Calculation	Pn202 = pulse No. of each encoder circle × 4 × mechanical deceleration ratio. Pn203 = (screw pitch/ pulse equivalent). Typical value: pitch 5mm, encoder 17-bit, deceleration ratio 1:1, pulse equivalent 0.001mm, Pn202=16384; Pn203=625.		
Pn203	Electronic gear ratio (denominator)	Need Calculation	Pitch 5mm, encoder 17-bit, deceleration ratio 1:1, pulse equivalent 0.0005mm, Pn202=8192; Pn203=625.		

9.1.2. Parameter Setting of DELTA ASDA-A Servo Driver

Para. No.	Function	Format & Range	Value	Description
P0-02	Driver status display		02	Monitor if the number of sent and received pulse is correct by setting this parameter. In Weihong control system, the correct quantity of pulse sent by control card is detected by pulse inspection in order to determine whether there is electrical interference.
P1-00	External pulse input type	ZYX	002	X=2: pulse + direction; Z=0: positive logic
P1-01	Control mode setup	ZYX1X0	0000	Z=0: during control mode switching, DIO is maintaining the set value, regardless of mode switching, so Z=0. Y=0: forward rotation (CCW) (in terms of load), Y=1, the rotation direction is reversed; X1X0=00: position control mode
P1-32	Motor stop mode selection	YX	00	Y=0: when there is no servo enabled, motor dynamic brake occurs; Y=1: motor is free. X=0: motor stops instantly, X=1: motor stops with deceleration.
P1-44	Electronic Gear Ratio (Numerator) (N1)	1~32767	Need calculation	$N1/M = \text{encoder pulses} \times 4 \times \text{pulse equivalent} \times \text{mechanical deceleration ratio} / \text{pitch}$. Representative value: encoder pulses=2500, pitch=5mm, pulse equivalent=0.001, deceleration ratio=1,
P1-45	Electronic Gear Ratio (Denominator) (M)	1~32767	Need calculation	calculation as below: $N1/M = 2500 \times 4 \times 0.001 / 5 = 2 / 1$, N1=2, M=1; When the multi-electronic gear ratio is not used, P2-60~ P2-62 are not required.
P2-10	Digital Input Pin DI1	X2X1X0	101	X1X0=01: digital input (DI1=SON) corresponds to 9th pin of CN1. X2 = 1: set DI1 input as NO (normally open) a-contact point.
P2-15	Digital Input pin DI6	X2X1X0	100	Default factory setting of DI6 and DI7 are NC (normally closed) limit signal input pins; driver can't run without being connected to pin 32 and pin 31 of CN1.
P2-16	Digital Input Pin DI7	X2X1X0	100	X2=1: set DI6 and DI7 inputs as NO (normally open) a-contact points; X1X0=00, limit signal input of the driver is not used.

Para. No.	Function	Format & Range	Value	Description
P2-17	Function setting for digital input pin DI8	X2X1X0	100	External EMG stop input is not used.
P2-21	Function setting for digital output pin DO4	X2X1X0	108	DO4 corresponds to pin 1 & pin 26, used as clamping-position brake signal of Z-axis; X2=1: set DO4 output as NO (normally open) a-contact point; X2=0: set DO4 output as NC (normally closed) b-contact point; X1X0=08: set pin 1 and pin 26 as BK+ and BK- respectively.
P2-22	Function setting for digital output pin DO5	X2X1X0	007	DO5 corresponds to pin 28 & pin 27, used as servo alarm signal. X2=0: set DO5 output as NC b-contact point. X1X0=07: set pin 28 and pin 27 as ALRM+ and ALRM- respectively.
P2-51	Servo ON (SON) setup		0	0: Servo ON must be triggered by numerical input signal. 1: when servo is powered, if there is no alarm signal, servo will be on automatically. Set 1 when there is no SON signal line.

9.1.3. Parameter Setting of DELTA ASDA-A2 Servo Driver

Para. No.	Function	Format & Range	Value	Description
P0-02	Driver status display		02	Monitor if the number of sent and received pulse is correct by setting this parameter. In Weihong control system, the correct quantity of pulse sent by control card is detected by pulse inspection in order to determine whether there is electrical interference.
P1-00	External pulse train input type	ZYX	002	X=2: pulse + direction; Z=0: positive logic
P1-01	Set control mode	ZYX1X0	0000	Z=0: during control mode switching, DIO is maintaining the set value. Since switching control mode is not used, Z=0; Y=0: forward rotation (CCW) (from the view of load); Y=1: the rotation direction is reversed. X1X0=00: position control mode
P1-44	Electronic Gear Ratio (Numerator)(N1)	1~32767	Need calculation	N1/M= mechanical deceleration ratio × 4 × encoder pulses × pulse equivalent / pitch. Representative value: encoder pulses=2500, pitch =5mm, pulse equivalent=0.001, deceleration ratio = 1, calculation as below: N1 / M = 2500×4×0.001/5 = 2/1, N1=2, M=1; When the multi-electronic gear ratio is not used, P2-60 ~P2-62 are not required.
P1-45	Electronic Gear Ratio (Denominator)(M)	1~32767	Need calculation	
P2-10	Digital Input Pin 1 (DI1)	X2X1X0	101	X1X0=01: digital input (DI1 = SON) corresponds to 9 th pin of CN1. X2=1: set DI1 input as NO (normally open) a-contact point.
P2-15	Function setting for digital input pin DI6	X2X1X0	100	Default factory setting of DI6 and DI7 is NC (normally closed) limit signal input; driver can't run without being connected to pin 32 and pin 31 of CN1. X2=1: set DI6 and DI7 input as NO a-contact points. X1X0=00, limit input of driver is not used.

Para. No.	Function	Format & Range	Value	Description
P2-16	Function setting for digital input pin DI7	X2X1X0	100	
P2-17	Function setting for digital input pin DI8	X2X1X0	100	External EMG stop input is not used.
P2-21	Function setting for digital output pin DO4	X2X1X0	108	DO4 corresponds to pin 1 & pin 26, used as clamping-position brake signal of Z-axis; X2=1: set DO4 output as NO (normally open) a-contact point; X2=0: set DO4 output as NC (normally closed) b-contact point; X1X0=08: set pin 1 and pin 26 as BK+ and BK- respectively.
P2-22	Function setting for digital output pin DO5	X2X1X0	007	DO5 corresponds to pin 28 & pin 27, used as servo alarm signal. X2=0: set DO5 output as NC b-contact point. X1X0=07: set pin 28 and pin 27 as ALRM+ and ALRM- respectively.

9.1.4. Parameter Setting of PANASONIC MINAS_A4 Servo Driver

Para. No.	Function	Value	Description
Pr01	LED initial status	12	Monitor if the number of sent and received pulse is correct by setting this parameter. In Weihong control system, the correct quantity of pulse sent by control card is detected by pulse inspection in order to determine whether there is electrical interference.
Pr02	Select control mode	0	0: position mode 1: velocity mode 2: torque mode
Pr40	Select command pulse input	1	1: input through difference exclusive circuit
Pr42	Select command pulse input mode	3	Set command pulse input mode: command pulse + command direction, negative logic
Pr48	The 1st numerator of the command pulse frequency multiplication	Need calculation Range: 1~10000	Typical values: pitch 5 mm, encoder resolution 10000, deceleration ratio 1:1, pulse equivalent 0.001 mm: Pr48=10000 Pr4B= pitch 5mm/ pulse equivalent 0.001mm=5000 So, Pr48/Pr4B=10000/5000=2/1
Pr4B	Denominator of the command pulse frequency multiplication	Need calculation Range: 1~10000	

After the parameters are set, writing mode of EEPROM has to be selected. Please refer to the following steps:

- ① Press [MODE] button → Select [EEPROM] → Enter mode [EE_SET];
- ② Press SET button, showing [EEP —];
- ③ Keep pressing UP direction key for approx. 3 seconds, then [EEP ——] will be displayed, and then writing starts until [Start] is displayed.

If [Finish] is displayed after saving the parameters, it means successful modification. If [Reset] is shown, alteration will be validated only after restarting the driver. If [Error] occurs, the write-in is a failure, and another setting is needed.

9.1.5. Parameter Setting of FUJI FALDIC-β Servo Driver

Para. No.	Name	Value	Description
01	Command pulse numerator α	Need calculation 1~32767	Command pulse numerator and denominator are also equal to those of the electronic gear ratio. $\alpha / \beta = \text{encoder resolution} \times \text{pulse equivalent} \times \text{mechanical deceleration ratio} / \text{screw pitch}$. Typical value: encoder resolution 65536, pitch 5mm, pulse equivalent 0.001, mechanical deceleration ratio 1, $\alpha / \beta = 65536 \times 0.001 / 5 = 8192 / 625$, So $\alpha = 8192$, $\beta = 625$.
02	Command pulse denominator β	Need calculation 1~32767	
03	Pulse string input form	0	Set the input mode of pulse string as: instruction + symbol, that is 'pulse + direction'.
04	Direction of rotation switch	0 or 1	Set 0: Positive direction: Forward rotation (CCW); Set 1: Positive direction: Reverse rotation (CW).
10	CONT1 signal distribution	1	CONT1 is distributed as RUN (i.e. SON); if not distributed, CONT1 will be auto ON if there is no alarming when powered.
11	CONT2 signal distribution	2	CONT2 is distributed as RST (i.e. servo alarming clearance CLR). When 12, 13, 14 are 0, that is CONT3, CONT4 and CONT5 can't be distributed as OT (over-travel) or EMG (external emergency stop).
15	OUT1 signal distribution	1	Set 1, OUT1 is distributed as a-contact point of alarming output; Set 2, OUT1 is distributed as b-contact point of alarming detection.
27	Parameter write-protection	0 or 1	Set 0, write-enable. Set 1, write-protected.
74	CONT Always ON 1	1	Its initial value is 0, and it is set "1" here to enable servo (RUN).

Note:

FUJI servo has no braking signal wire, so there is no need to set the parameters related to braking; you only need to provide 24V brake power to pin Br (lead wire 5 and 6) of motor with braking.

9.1.6. Parameter Setting of STONE GS Servo Driver

Para. No.	Para. Name	Value	Description																							
F0f	Electronic gear ratio numerator	2	Electronic gear ratio of position mode: $4 \times \text{pulse frequency fed back by motor encoder} = \text{command pulse frequency} \times F0f / F10$; value of $F0f / F10$ must be within 1/100~100. (calculated with pitch as 10mm)																							
F10	Electronic gear ratio denominator	1																								
F00	Control mode selection	2	<p>0: external speed running mode; make sure the value and direction of motor speed according to the external analog -10V ~ +10V signal of CN2-16, 17;</p> <p>1: internal speed running mode; make sure the value and direction of motor speed according to the setting of parameter F33, F35, F37, F39 and the port status of CN2-9, CN2-25;</p> <p>2: position pulse running mode; receive the input of external position command pulse and direction level signal;</p> <p>3: jog mode; make sure the motor speed in terms of parameter setting of F3b, and control the rotation direction by the direction keystroke ▼ and ▲;</p> <p>4: torque mode; make sure the value and direction of motor torque according to the external analog -10V ~ +10V signal of CN2-43, 1;</p> <p>5~10: mixed mode; select mode according to the port input status of CN2-24:</p> <table border="1" data-bbox="700 1301 1382 1682"> <thead> <tr> <th rowspan="2">F00 Value</th> <th colspan="2">CN2-24 Interface Status</th> </tr> <tr> <th>OFF (Mode One)</th> <th>ON (Mode Two)</th> </tr> </thead> <tbody> <tr> <td>5</td> <td>Position Pulse Mode</td> <td>External Speed Running Mode</td> </tr> <tr> <td>6</td> <td>Position Pulse Mode</td> <td>Internal Speed Running Mode</td> </tr> <tr> <td>7</td> <td>Position Pulse Mode</td> <td>Torque Mode</td> </tr> <tr> <td>8</td> <td>Internal Speed Running Mode</td> <td>External Speed Running Mode</td> </tr> <tr> <td>9</td> <td>Internal Speed Running Mode</td> <td>Torque Mode</td> </tr> <tr> <td>10</td> <td>External Speed Running Mode</td> <td>Torque Mode</td> </tr> </tbody> </table>	F00 Value	CN2-24 Interface Status		OFF (Mode One)	ON (Mode Two)	5	Position Pulse Mode	External Speed Running Mode	6	Position Pulse Mode	Internal Speed Running Mode	7	Position Pulse Mode	Torque Mode	8	Internal Speed Running Mode	External Speed Running Mode	9	Internal Speed Running Mode	Torque Mode	10	External Speed Running Mode	Torque Mode
F00 Value	CN2-24 Interface Status																									
	OFF (Mode One)	ON (Mode Two)																								
5	Position Pulse Mode	External Speed Running Mode																								
6	Position Pulse Mode	Internal Speed Running Mode																								
7	Position Pulse Mode	Torque Mode																								
8	Internal Speed Running Mode	External Speed Running Mode																								
9	Internal Speed Running Mode	Torque Mode																								
10	External Speed Running Mode	Torque Mode																								
F2e	Pulse input mode selection	2	Command pulse string mode selection of position mode:																							

Para. No.	Para. Name	Value	Description								
			1 - single pulse string positive logic <table border="0" style="display: inline-table; vertical-align: middle;"> <tr> <td>pulse</td> <td>12</td> <td>27</td> <td></td> </tr> <tr> <td>direction</td> <td>13</td> <td>28</td> <td></td> </tr> </table>	pulse	12	27		direction	13	28	
pulse	12	27									
direction	13	28									
			2 - single pulse string negative logic <table border="0" style="display: inline-table; vertical-align: middle;"> <tr> <td>pulse</td> <td>12</td> <td>27</td> <td></td> </tr> <tr> <td>direction</td> <td>13</td> <td>28</td> <td></td> </tr> </table>	pulse	12	27		direction	13	28	
pulse	12	27									
direction	13	28									
			3 - double pulse strings positive logic <table border="0" style="display: inline-table; vertical-align: middle;"> <tr> <td>CCW</td> <td>12</td> <td>27</td> <td></td> </tr> <tr> <td>CW</td> <td>13</td> <td>28</td> <td></td> </tr> </table>	CCW	12	27		CW	13	28	
CCW	12	27									
CW	13	28									
			4 - double pulse strings negative logic <table border="0" style="display: inline-table; vertical-align: middle;"> <tr> <td>CCW</td> <td>12</td> <td>27</td> <td></td> </tr> <tr> <td>CW</td> <td>13</td> <td>28</td> <td></td> </tr> </table>	CCW	12	27		CW	13	28	
CCW	12	27									
CW	13	28									
			5 - quadrature pulse positive logic <table border="0" style="display: inline-table; vertical-align: middle;"> <tr> <td>phase A</td> <td>12</td> <td>27</td> <td></td> </tr> <tr> <td>phase B</td> <td>13</td> <td>28</td> <td></td> </tr> </table>	phase A	12	27		phase B	13	28	
phase A	12	27									
phase B	13	28									
			6 - quadrature pulse negative logic <table border="0" style="display: inline-table; vertical-align: middle;"> <tr> <td>phase A</td> <td>12</td> <td>27</td> <td></td> </tr> <tr> <td>phase B</td> <td>13</td> <td>28</td> <td></td> </tr> </table>	phase A	12	27		phase B	13	28	
phase A	12	27									
phase B	13	28									

9.1.7. Parameter Setting of MITSUBISHI MR-E Servo Driver

Para. No.	Code	Function	Value	Description
0	*STY	Select control mode and regenerative fittings	X0X0	Bit 0: set 0: select position control mode. Bit 1, select motor series: 0: HC-KFE; 1: HC-SFE; Bit 3, select regenerative apparatus, set 0: not use. Bit 4, select motor power.
1	MBR	Function selection 1	001X	Bit 0: input signal filter. If external input signal causes chattering due to noises, etc., input filter is used to suppress it. Bit 1: CN1-12 function selection, set "1": electromagnetic brake interlock (MBR); set "0": zero speed detection signal.
3	CMX	Electronic gear numerator	Need calculation	CMX/CDV=command unit × servo motor resolution × mechanical deceleration ratio / pitch of screw. E.G., pitch 5 mm, encoder resolution 10000, deceleration ratio 1:1, pulse equivalent 0.001 mm, CMX/CDV=10000×0.001/5 = 2/1; When pulse equivalent = 0.0005mm, CMX/CDV = 1/1. Electronic gear ratio range: 1/50 ~ 500
4	CDV	Electronic gear denominator	Need calculation	

Para. No.	Code	Function	Value	Description
18	*DMD	Status display selection	00XX	3: cumulative command pulses E: load inertia When the parameter is set [3], monitor if the number of sent and received pulse is correct by setting this parameter. In Weihong control system, the correct quantity of pulse sent by control card is detected by pulse inspection to determine if there is electrical interference.
21	*OP3	Function selection 3 (command pulse format selection)	0001	Set pulse command input form: pulse train+ sign, negative logic
41	*DIA	Signal input SON-ON, LSP-ON and LSN-ON automatically selection	0110	Bit 0: Servo-ON selection. [0]: servo on by external input; [1]: servo on all the time inside. Bit 1: last signal of positive rotation range (LSP): [1]: auto servo on inside, without external wiring. Bit 3: last signal of negative rotation range (LSN) : [1]: auto servo on inside and no need of external wiring.

(Note: regarding parameters with the symbol “*” in front, when changed, they will be effective after re-power on the driver.)

9.2. Wiring Diagram of NK105 and Driver

9.2.1. Wiring Diagram of NK105 and Differential Input Stepping Driver

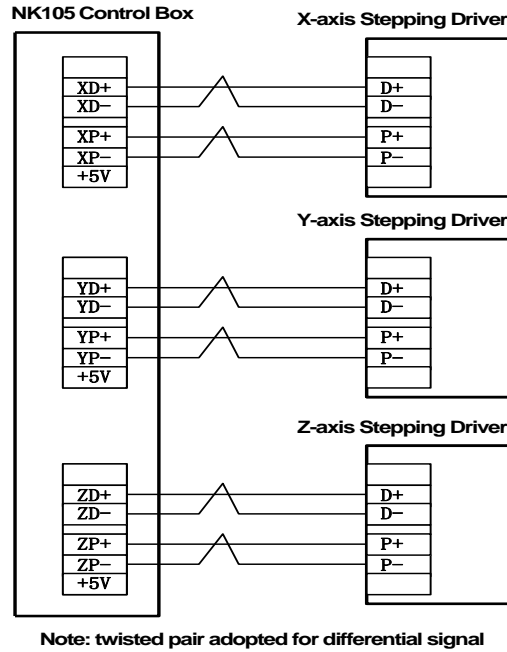

Fig. 9-1 Wiring of NK105 control box and differential input stepping driver

9.2.2. Wiring Diagram of YASKAWA Σ -II Servo Driver

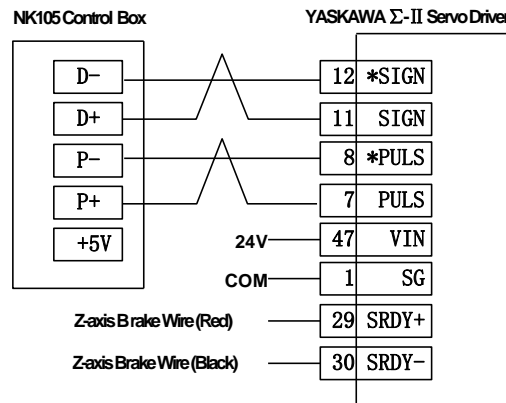

Fig. 9-2 Wiring diagram of NK105 and YASKAWA Σ -II servo driver

Note: Wirings of X axis, Y axis, and Z axis are the same. Only Z axis has two brake signal lines which can be connected to relay to control brake.

9.2.3. Wiring Diagram of DELTA ASDA Servo Driver

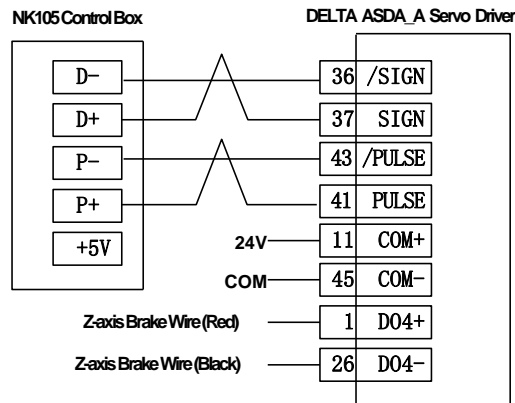

Fig. 9-3 Wiring diagram of NK105 and DELTA ASDA_A servo driver

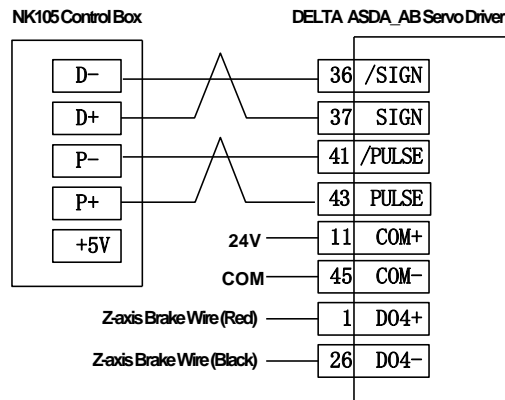

Fig. 9-4 Wiring diagram of NK105 and DELTA ASDA_AB servo driver

Note: Wirings of X axis, Y axis, and Z axis are the same. Only Z axis has two brake signal lines which can be connected to relay to control brake.

9.2.4. Wiring Diagram of PANASONIC MINAS_A4 Servo Driver

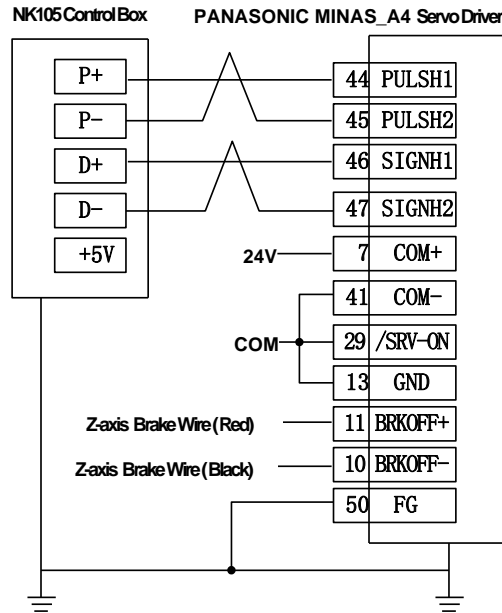

Fig. 9-5 Wiring diagram of NK105 and PANASONIC MINAS_A4 servo driver

Note: Wirings of X axis, Y axis, and Z axis are the same. Only Z axis has two brake signal lines which can be connected to relay to control brake.

9.2.5. Wiring Diagram of MITSUBISHI MR-E Servo Driver

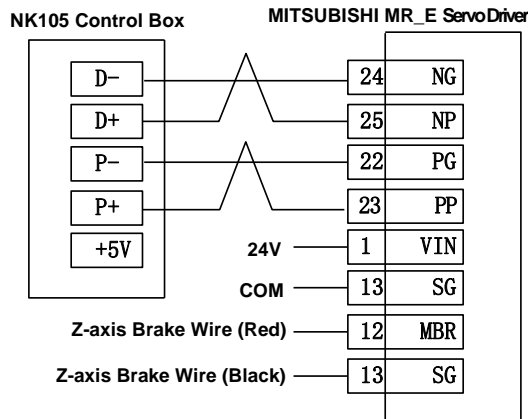

Fig. 9-6 Wiring diagram of NK105 and MITSUBISHI MR-E servo driver

Note: Wirings of X axis, Y axis, and Z axis are the same. Only Z axis has two brake signal lines which can be connected to relay to control brake.

9.2.6. Wiring Diagram of FUJI FALDIC-β Servo Driver

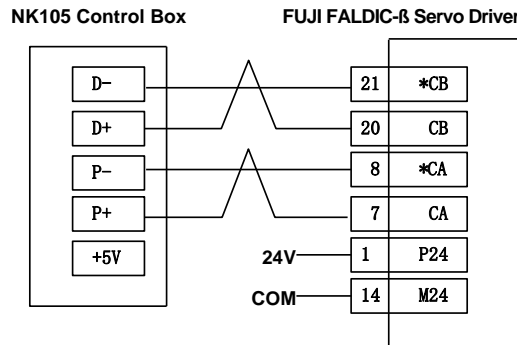

Fig. 9-7 Wiring diagram of NK105 and FUJI FALDIC-β servo driver

Note: Wirings of X axis, Y axis, and Z axis are the same, and the brake of Z axis is internally controlled.

9.2.7. Wiring Diagram of STONE GS Servo Driver

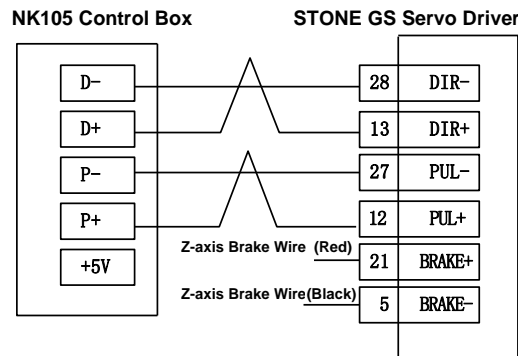

Fig. 9-8 Wiring diagram of NK105 and STONE GS servo driver

Note: Wirings of X axis, Y axis, and Z axis are the same. Only Z axis has two brake signal lines which can be connected to relay to control brake.

10. Software License Agreement

Important—Read Carefully before Using This Product:

The term “Software Product” includes all copies of the licensed software and its documentation. This license agreement is a legal agreement between You (either an individual, a legal entity or any affiliated companies or other entities) and Weihong Electronic Technology Co., Ltd. (hereinafter referred to as Weihong Company). By installing, copying, or otherwise using the Software Product, you agree to be bound by the terms and conditions of this license. Unless otherwise stated in this agreement, you shall not use, copy, revise, rent, or transfer the Software product or any part of the Software Product for any other purposes.

Description of Further Rights and Restrictions:

1. You may install for use one copy of the Software Product on a single machine;
2. You may make a copy of the Software Product for archive or backup purposes and the copy is to be used on this machine only;
3. You may transfer the Software Product and the license agreement to a third party, provided that the third party accepts the terms and conditions stated in this agreement, with prior express permission from Weihong Company;
4. When transfer confirmed, you shall transfer all the copies of the original documents and the supplementary documents to the third party or destroy all the copies un-transferred.
5. You can use the Software Product on a network server or intranet server only if it is stipulated in explicit terms that you are allowed to use the Software Product on a network server or intranet server, or you have purchased license for each node and terminal using the Software Product;
6. You may NOT sublicense, assign or transfer the license agreement;
7. You may NOT or direct any third party to reverse engineer, decompile or disassemble the Software Product;
8. You may NOT copy or transfer the Software Product or any part of the Software Product unless otherwise expressly stated in this agreement;
9. The license agreement shall be terminated automatically upon you transfer the Software Product or copies of all or part of the Software Product to a third party.

Intellectual Property Rights Notice:

The Software Product and all intellectual property rights therein (including but not limited to any all copyrights, patents, trademarks, and publicity rights) are owned by Weihong Company. The Software Product is protected for Weihong Company on the basis of copyright law and international treaty provisions as well as on the basis of other laws and agreements regarding intellectual

property. You are not allowed to remove the copyright statement made in the Software Product, and guarantee that you shall copy the copyright statement in all copies of the Software Product or of any part of the Software Product. You are obliged to stop any form of illegal copying of the Software Product and accompanying materials.

After-sales Guarantee:

Weihong Company guarantees that for 90 days from the date of shipment the software carrier will be free from defects in materials and workmanship. When such a defect has been confirmed, our only responsibility is to replace the software carrier. This remedy is your exclusive remedy. This after-sales guarantee is invalid for any carrier defect caused by accidents, abuses or maloperation. The replaced software carrier enjoys the remaining guarantee time of the original software carrier or of a 30-day guarantee time, whichever is longer.

Except as the after-sales guarantee made above, the Software Product does not enjoy any other form of after-sale guarantee.

Limitation of Liability:

The above guarantee, whether made explicitly or by implication, constitutes the entire contents of the guarantee, including guarantee for the commerciality and applicability of special application aim. Whether you follow other terms in this agreement or not, Weihong Company, as well as its agents and sales staff, will not be responsible for any profits loss, availability loss, business break-off or any forms of indirect, special, accidental or inevitable damage or claim made by any third party, generated from the using of the Software Product, even if Weihong Company has been informed of the possible occurrence of such events in advance.

Termination:

This license may be terminated by Weihong Company at any time once you violate any terms or conditions made in this agreement. Once the license is terminated, you are obliged to destroy all the copies of the Software Product or return them to Weihong Company.

Applicable Law:

Copyright Law, Regulations for the Protection of Computer Software, Patent Law and other relevant laws and regulations.

Now, we affirm that you have already read through this agreement and understood it thoroughly and agreed to comply with all of the terms and conditions of this agreement strictly.

Weihong Electronic Technology Co., Ltd.

WEIHONG ELECTRONIC TECHNOLOGY CO., LTD.

ADD: No. 29, 2338 Duhui Rd., Minhang, Shanghai 201108, PRC

TEL : +86-21-33587550

Website: <http://en.weihong.com.cn>

E-mail: sales_weihong@188.com support_weihong@188.com

RMB: 27.00